



ANIMAL HEALTH

Equipment Catalog

2023



Solutions designed for companion animals and their care providers.

Better care doesn't happen by chance—it happens by design. Design that takes into account not just the space, but the people working in it. At Midmark, we believe that when you harmonize space, workflow and technology, it leads to healthier pets, happier clients and staff, and it contributes to the success of the organization. It's this attention to our customers and design that has enabled us to transform animal care environments.



Get the support you deserve

Designing a better care experience starts with a better customer experience. At Midmark, we make it our mission to thoroughly address every customer need and always fulfill our commitments.



Midmark Customer Experience

Available to serve your needs from 8:00 AM - 5:00 PM, Monday through Friday (ET).

Midmark Versailles Customer Experience*

Phone 1.844.856.1236
email: animalhealth@midmark.com
fax: 1.877.725.6495

Midmark Synthesis Cabinetry

Phone: 1.844.856.1236

Midmark Carthage Customer Experience**

Phone: 1.800.299.9525
Email: Carthage@midmark.com

Midmark Leesburg Customer Experience

Phone: 1.844.856.1236
Email: Leesburg@midmark.com

Midmark Technical Service

Available to serve your needs from 8:00 AM - 5:00 PM Monday through Friday (ET)

Phone: 1.844.856.1232

Then choose the product category for which you need assistance from the menu.

Boarding + Shelter Products***

Phone: 1.844.856.1236

Midmark AcademySM

midmarkacademy.com

*Ordering information for products produced in our Versailles, OH facility appear in **BLUE**. To order, contact us at the phone number listed next to the **BLUE** box at the bottom of the page.

Ordering information for products produced in our Carthage, MO facility appear in **RED. To order, contact us at the phone number listed next to the **RED** box at the bottom of the page.

***Ordering information for products produced in our Leesburg, OH facility appear in **TEAL**. To order, contact us at the phone number listed next to the **TEAL** box at the bottom of the page.

Contents

Absorber Quick Release Conversion Kit	16	Luxury Cat Condos	59
Anesthesia Machines:		Luxury Walk-In Dog Suites	42
VME2 [®]	9-10	Maintenance Kits, Anesthesia Machine	16
VMR [®]	11-12	Masks, Small Animal Anesthesia	25
VMS [®]	8, 10	Mayo Tray Cart	28
VMS [®] Plus	7	Midmark Academy Training Packages	109-110
Non-rebreathing Systems	11-12	Modular 2-Story Double Deck Kennels	43
Wall Mount, Tabletop Systems	10-12	Monitor Mounts	115
Anesthesia Monitoring Training	108	Monitors	111-114
Autoclaves and Accessories	96-97	Occlusion Valve	16
Breathing Circuits	18	Prophy Angles	87
Burs	87	Quiet Cottages Fiberglass Cages	35, 58
Cabinetry	62-83	Raintree Cat Condos	55
Cages, Stainless Steel	31-34	Emergency Response Resuscitator Kits	28
Carts (Mobile and Procedure)	74-79	Rubber Goods	19
Cat Condos	55, 59	Sani-Kennels	44
Cat Solution Accessories	60	Scaler Tips	88
Cat Suites, Fiberglass	58	Scales	104
Cat Towers	56	Scavengers	21-22
Chain Link Runs	39-40	Silvis Seal [™] + Sani-Slope [™]	45
Chairs and Stools	117-124	Space Saver Folding Kennel	52
CO ₂ Absorbent	15	Sterilizers and Accessories	96-97
Color Chart-Cabinetry	69-73	Surgery Tables, Stainless Steel	139-140
Color Chart-Upholstery	123-124	Tables, Wet/Prep/Exam, Lift, Dry Exam	125-146
Custom Cat Runs	57	Tri-Kennels	53
Cylinder Mounting Blocks	15	Tubs	147, 151-152
Dental Delivery Accessories	87-88	UltraBase [™] Above Floor Kennels	51
Dental Delivery Systems	85	Ultrasonic Cleaners	95
Dental Radiography	89-91	Urolithiasis Probes	88
Dental Training Network	107	Vaporizer Service + Exchange Programs	14
Dog Daycare Room Dividers	38	Vaporizers, VIP 3000	13
Dog Solution Accessories	54	Ventilator, Midmark Model 3002PRO	23
Dryer Cages	36	Ventilator Accessories	24
Endotracheal Tubes, Sterile	26	Workstations	80-82
Faucets and Sinks	148-150		
Oxygen Flowmeters	17	Warranty Information	153-154
Fluid Warmer, IV	25	Ordering Information	155-156
Handpieces	86, 88	Midmark Locations	157
Hose Assemblies	20		
Instrument Processing Workflow	98		
ISO-Care Quarantine Cages	37		
K-9 Cabin Double Stacked System	41		
Kennels, Stainless Steel and Accessories	46-50		
Laryngoscope Blades and Handles	27		
Lift Tables	134, 136-138		
Lights	99-103		

Pricing and product availability in this catalog supersede information in all other catalogs. Products and prices are subject to change or discontinuation without prior notice. Midmark prices that are in effect when your order is received will be honored even if the items are temporarily out of stock.

Anesthesia

Midmark anesthesia machines (formerly MatrX®) are a longtime favorite of veterinary professionals around the world for inhalation anesthesia delivery. For over 50 years, each machine has been carefully manufactured to provide you with years of simple and controllable inhalation anesthesia delivery. With wall, stand and tabletop configurations, we are sure to have the anesthesia delivery solution that fits your clinic needs.



Anesthesia Machines

VMS® Plus

The VMS® Plus provides the functionality you need with two shelves for convenient placement of monitors and equipment. Its dual-vaporizer mounting capability allows you to easily switch from one vaporizer to another.

- Includes Occlusion Valve with safety relief to prevent unsafe build-up in the anesthesia circuit/patient
- Negative Pressure Relief Valve—opens to provide room air to patient if contents of breathing bag are depleted
- Dual-view oxygen flowmeter—glass tube with a scale reading from 0.2 to 4 LPM—quickly switch from standard to magnified view at the touch of a finger
- Easy-to-view inhalation/exhalation valves allow easy monitoring of respiration for patient safety—no tools needed to disassemble
- Oxygen flush
- 1,500 cc CO₂ absorber with quick release lever feature for easy absorbent replacement (accepts prepack canisters or 1,350 grams loose absorbent)
- Scavenging/adjustable pressure limiting (APL) valve
- Breathing circuit pressure gauge
- 15 mm and 22 mm diameter corrugated breathing circuits
- One- and two-liter breathing bags
- Chrome portable stand with 5-leg spider base and casters
- Convenient monitor shelves
- Accepts Midmark VIP 3000® and TEC 3 vaporizers (one mounting kit included)
- Dual-vaporizer mount capability
- Oxygen low-flow flowmeter add-on capability
- Includes starter pack of Sodasorb LF



5 YEAR
LIMITED WARRANTY

91800081

Top Shelf 22 1/2" W x 6 1/2" D
Bottom Shelf 22 1/2" W x 13" D

91800081	VMS® Plus (USA)	\$3,566.00
91800075	VMS® Plus (ISO/Canadian)	\$3,566.00
91800709	Low Flow O ₂ Kit (USA)	\$940.00
91800707	Low Flow O ₂ Kit (ISO/Canadian)	\$940.00
91800129	IV Holder Kit	\$179.00
91305187	Mounting Kit for Second Vaporizer	\$40.00

ACCESSORIES

Note: For Midmark VIP 3000® Vaporizers, see page 13.
For cylinder mount blocks, see page 15.



91800129





91800003



91805140



91805152

20232800
(Table Sold Separately)

FM 53823

VMS®

The VMS® small animal anesthesia machine is a long-time favorite of veterinary professionals. It is designed for safe, simple and controllable small animal inhalation anesthesia. Optional shelves available.

- Includes Occlusion Valve with safety relief to prevent unsafe build-up in the anesthesia circuit/patient
- Negative Pressure Relief Valve—opens to provide room air to patient if contents of breathing bag are depleted
- Dual-view oxygen flowmeter—glass tube with a scale reading from 0.2 to 4 LPM—quickly switch from standard to magnified view at the touch of a finger
- Easy-to-view inhalation/exhalation valves allow easy monitoring of respiration for patient safety—no tools needed to disassemble
- Oxygen flush
- 1,500 cc CO₂ absorber with "Quick Release" lever feature for easy absorbent replacement (accepts prepack canisters or 1,350 grams loose absorbent)
- Scavenging/adjustable pressure limiting (APL) valve
- Breathing circuit pressure gauge
- 15 mm and 22 mm diameter corrugated breathing circuits
- One- and two-liter breathing bags
- Chrome portable stand with 5-leg spider base and casters
- Accepts Midmark VIP 3000® and TEC 3 vaporizers (mounting kit included)
- Oxygen low-flow flowmeter add-on capability
- Includes starter pack of Sodasorb LF

91800003	VMS® (USA)	\$3,303.00
91800070	VMS® (ISO/Canadian)	\$3,303.00
91800042	VMS® Wall Mount (USA)	\$3,303.00
20232800	VMS® w/ CM Wet Lift Table Mount (swing arm included)	\$3,303.00
40165601	Swing Arm Mount for VMS® to CM Wet Lift Table	\$603.00
91800709	Low Flow O ₂ Kit (USA)	\$940.00
91800138	Quick Release Absorber Conversion Kit	\$191.00
93305007	Post Mount Assembly (for adding second vaporizer)	\$333.00
91800167	VMS® to VMS® Plus Conversion Kit	\$894.00
91805152	Ventilator Shelf for VMS®	\$338.00
91805140	Tray Shelf for VMS®	\$304.00

ACCESSORIES

Note: For Midmark VIP 3000® Vaporizers, see page 13. For cylinder mount blocks, see page 15.

NOTE: For ordering information or to ask about part number items shown above, contact us at **1.844.856.1236**.

[Back to Contents](#)

VME2®

The sleek, compact design of the VME2® can be upgraded with optional add-on components such as shelves, a second flowmeter, a second vaporizer, an occlusion valve with safety relief and/or an emergency air intake valve.

- Dual-view oxygen flowmeter—glass tube with a scale reading from 0.2 to 4 LPM—quickly switch from standard to magnified view at the touch of a finger
- Easy-to-view inhalation/exhalation valves allow easy monitoring of respiration for patient safety—no tools needed to disassemble
- Oxygen flush
- 1,100 cc CO₂ absorber and starter pack of Sodasorb® LF
- Scavenging/adjustable pressure limiting (APL) valve
- Breathing circuit pressure gauge
- 15 mm and 22 mm diameter corrugated breathing circuits
- One- and two-liter breathing bags
- Portable stand with 5-leg spider base and casters
- Convenient accessory shelf
- Accepts Midmark VIP 3000® and TEC 3 vaporizers (single mounting kit included)



5 YEAR
LIMITED WARRANTY

91805111

91805111	VME2® (USA)	\$2,412.00
91805112	VME2® (ISO/Canada)	\$2,412.00
93805114	Occlusion Valve	\$158.00
91805118	Dual Vaporizer Mount Kit	\$380.00
91805121	Emergency Air Intake Valve and Dome Kit	\$199.00
91805143	VME2® Ventilator Shelf	\$346.00
91805142	VME2® Tray Shelf	\$338.00
91805144	Slot Shelf	\$197.00



91805142



91805143



91805144



93805114



91805117



91805118



91805121

ACCESSORIES

Note: For Midmark VIP 3000® Vaporizers, see page 13.
For cylinder mount blocks, see page 15.



FM 53823

Wall Mount/Tabletop Systems



91800042 (Vaporizer Sold Separately)

VMS® Wall Mount

Our most popular anesthesia machine is available in a wall-mount configuration.

- Includes occlusion valve and starter pack of Sodasorb® LF
- Simple to install
- Small surface area design
- Pivot arm rotates 130 degrees and extends to 8" from wall
- Accepts Midmark VIP 3000® or TEC 3 vaporizers (mounting kit included)

91800042	VMS® Wall Mount (USA)	\$3,303.00
91800166	VMS® Wall Mount (ISO)	\$3,303.00
91800709	Low Flow O ₂ Kit (USA)	\$940.00
91800186	Vaporizer Wall Mount Kit (for adding 2nd vaporizer)	\$326.00



91800094 (Vaporizer Sold Separately)

VME2® Wall Mount/Tabletop System

Flexibility and performance at a low price.

- Light weight – 16 lb
- Compact design: 18 1/8" H x 16 1/4" W x 7 1/2" D
- Convenient carry handle with soft vinyl grip
- Accepts VIP 3000® or TEC 3 vaporizers (mounting kit included)
- 0.2 to 4 LPM dual-view oxygen flowmeter with standard and magnified views
- 1,100 cc CO₂ absorber and starter pack of Sodasorb® LF
- Rubber foot pads help prevent scratching of countertop
- Breathing circuit package included
- Optional wall mount kit is available
- Low-flow model replaces the 0.2 to 4 LPM flowmeter with a 0-1000 cc oxygen flowmeter

91800094	VME2® Tabletop	\$2,564.00
91800121	VME2® Tabletop (ISO/Canada)	\$2,564.00
91800103	Optional Wall Mount Kit	\$183.00
93805114	Occlusion Valve	\$158.00
91805121	Emergency Air Intake Valve and Dome Kit	\$199.00



FM 53823

ACCESSORIES

Note: For Midmark VIP 3000® Vaporizers, see page 13.

NOTE: For ordering information or to ask about part number items shown above, contact us at **1.844.856.1236**.

[Back to Contents](#)

Non-rebreathing Anesthetic Delivery Systems

VMR™ Low-flow Non-rebreathing System

Designed for safe, simple and controllable inhalation anesthesia for rats, small rodents, exotics and patients weighing less than 5 lb (2.27 kg). The VMR provides rapid control of anesthetic depth with little resistance to respiration.

- Non-rebreathing anesthetic delivery system
- Dual-view oxygen flowmeter—glass tube with a scale that reads from 0-1,000 cc/min—quickly switch from standard to magnified view at the touch of a finger
- Includes well-fill or key-fill isoflurane or well-fill sevoflurane VIP 3000® vaporizer
- Tabletop models feature a built-in handle and rubber feet
- Standard flow (0.2-4 LPM) and wall mount models also available

VMR w/Isoflurane Well-Fill Vaporizer

91800218	(USA)	\$2,753.00
91800236	(ISO/Canada)	\$2,753.00

VMR w/Isoflurane Key-Fill Vaporizer

91800219	(USA)	\$3,064.00
91800237	(ISO/Canada)	\$3,064.00

VMR w/Sevoflurane Well-Fill Vaporizer

91800261	(USA)	\$2,753.00
91800262	(ISO/Canada)	\$2,753.00

VMR Wall Mount

91800223	VMR Wall Mount with Isoflurane Well-Fill Vaporizer (USA)	\$2,753.00
91800224	VMR Wall Mount with Isoflurane Key-Fill Vaporizer (USA)	\$3,064.00

ACCESSORIES

91805100	0.2-4 LPM Add-on Kit (USA)	\$1,102.00
----------	----------------------------	------------



91800218



FM 53823

VMR™ Low-flow Tabletop Non-rebreathing System

91805060	VMR Tabletop with Isoflurane Well-Fill Vaporizer (USA)	\$2,753.00
91805061	VMR Tabletop with Sevoflurane Well-Fill Vaporizer (USA)	\$2,753.00
94805059	VMR Tabletop Assembly (USA) (Vaporizer Sold Separately)	\$1,376.00
91806300	VMR Tabletop Assembly (ISO) (Vaporizer Sold Separately)	\$1,376.00

O₂ Flowmeter Assembly for VMR®

92805097	(USA)	\$788.00
91805098	(ISO/Canada)	\$788.00



91805060



FM 53823

NOTE: For ordering information or to ask about part number items shown above, contact us at **1.844.856.1236**.

[Back to Contents](#)

Vaporizers

VIP 3000[®] Vaporizer

The VIP 3000[®] veterinary vaporizer uses proven design principles to ensure output concentration is virtually unaffected by flow rate, temperature variations, duration of use, liquid level or back-pressure fluctuation within its clinical range.

- Automatic flow rate and temperature compensation
- Large, easy-to-read dial
- Integrated safety lock to prevent unintentional engagement
- Large sight-glass for at-a-glance liquid level monitoring
- Choice of agent-specific models for isoflurane or sevoflurane

5 YEAR
LIMITED WARRANTY



91305430	Isoflurane VIP 3000 [®] , Well-Fill For use with isoflurane. 0.5%–5.0% at 1/2% intervals.	\$1,526.00
91305418	Isoflurane VIP 3000 [®] , Key-Fill For use with isoflurane. 0.5%–5.0% at 1/2% intervals. Includes Key-fill Adapter 91305421	\$1,853.00
91305507	Sevoflurane VIP 3000 [®] , Well-Fill For use with sevoflurane. 0.25%–8.0% at 1% intervals.	\$1,526.00
40140201	Sevoflurane VIP 3000 [®] , Key-Fill For use with sevoflurane. 0.25%–8.0% at 1% intervals. Includes Key-fill Adapter 10566000	\$1,853.00



Easy-to-Read Detent Dial



Simple-to-Use Fill Port

Vaporizer mounting hardware is included with each Midmark anesthesia machine.

Mounting Kits

002-1844-00	For VMS [®] /VMC/VML [™]	\$63.00
91305187	For VME [®] /VMS [®] Plus/VME2 [®]	\$40.00
93305007	Post Mount Assembly (For adding second vaporizer to VMS [®])	\$333.00

ACCESSORIES

91305421	(A) Isoflurane Key-Fill Adapter	\$290.00
10566000	(B) Sevoflurane Key-Fill Adapter	\$290.00
92305072	(C) FS-2A Inlet Tubing Adapter	\$53.00
92305073	(D) FS-2 Outlet Tubing Adapter	\$51.00
91315075	7/16" OD x 1/4" ID Hose	\$0.30/in.
91800186	Vaporizer Wall Mount	\$326.00

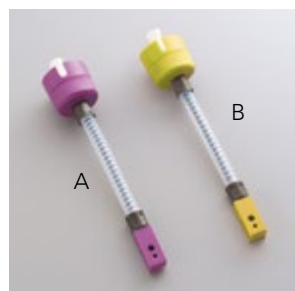

FM 53823

Vaporizer Service

FACTORY SERVICE FOR ACCURATE, RELIABLE OPERATION

To assure continued accuracy and reliability, every Midmark VIP 3000® vaporizer should be serviced and calibrated annually.

SERVICE INCLUDES:

- Complete disassembly and cleaning
- Ultrasonic bath to clean internal metal parts
- Calibration and adjustment of Thermo Control
- Reassembly with new seals and wick*
- Cleaning/polishing of exterior parts

Vaporizers ARE NOT field serviceable. Disassembly or service by anyone other than an authorized Factory Service Technician may result in damage or subsequent unsafe operation of the vaporizer.

* If additional parts are required, you will be contacted with an estimate.

Midmark VXP™ Vaporizer Exchange Program

If you own a Midmark or Matrix® vaporizer, contact your dealer and request a Midmark VXP. You will receive a vaporizer for the agent you specify (isoflurane or sevoflurane). Simply exchange your vaporizer with the Midmark VXP™ vaporizer and return it to the Midmark Vaporizer Service Center in the shipping carton in which you received your Midmark VXP™ unit.

When you receive your Midmark VXP™ vaporizer, mount it on your machine and you're ready to go. Enjoy no down time and the confidence of a cleaned, calibrated and tested vaporizer.

The Midmark VXP™ Vaporizer you receive has undergone the complete Midmark Vaporizer Service Center protocol. Contact your dealer for the latest program details.

91305535	Isoflurane VXP™ Well-fill Vaporizer	\$485.00
91305534	Isoflurane VXP™ Key-fill Vaporizer	\$485.00
91305537	Sevoflurane VXP™ Well-fill Vaporizer	\$485.00
10601700	Sevoflurane VXP™ Key-fill Vaporizer	\$485.00



Our Vaporizer Service Center is staffed with highly qualified service technicians using state-of-the-art equipment. The Midmark VIP 3000® Vaporizer is a sophisticated device and under no circumstance should be tampered with or disassembled by anyone other than a Midmark-authorized vaporizer service technician. These units ARE NOT field serviceable.

Service

For complete details on vaporizers requiring service, or availability of rental vaporizers, contact your local Midmark veterinary dealer.

For vaporizer service outside the United States and Canada, please contact the Midmark Vaporizer Service Center.

Midmark Corporation
Vaporizer Service Center
Plant B, St. Rt. 47 West, Versailles, OH 45380 USA
1.844.856.1236

R/R-ISO VAP	Isoflurane Vaporizer Service	\$485.00
R/R-SEVO VAP	Sevoflurane Vaporizer Service	\$485.00

NOTE: For ordering information or to ask about part number items shown above, contact us at 1.844.856.1236.

[Back to Contents](#)

Anesthesia Machine Accessories

Sodasorb® CO₂ Absorbent

The next generation of CO₂ absorbent with safety you can see.

- Permanent, high-contrast color change when absorbent capacity is exhausted or if absorbent becomes desiccated
- Eliminates the potential dangers that come with inhalation anesthesia such as the production of compound A, carbon monoxide, and heat generation due to desiccation
- Unique formulation makes the use of anesthetic agents more efficient
- Minimal resistance to gas flow
- Unique, uniform, pellet shape reduces caustic dust making for cleaner equipment and faster change-out
- Proven safety record ensures the comfort and well-being of both patients and staff
- Sodasorb® LF is available in jugs, convenient pre-pack cartridges and Canister Pak bags. Standard Sodasorb® is available in pre-pack cartridges, Canister Pak bags and a five-gallon pail.



002-1761-00	Sodasorb® LF Canister-pak Bag, Case of 12	\$160.00
002-1763-00	Sodasorb® LF Pre-pak Cartridge, Case of 12	\$219.00
002-1909-00	Sodasorb® LF Jug, Case of 3	\$145.00
002-1762-00	Standard Sodasorb® Canister-pak Bag, Case of 12	\$135.00
002-1764-00	Standard Sodasorb® Pre-pak Cartridge, Case of 12	\$184.00
002-1765-00	Standard Sodasorb® Five Gallon Pail	\$135.00

Cylinder Mounting Blocks

Small "E" or "D" size cylinder mounting blocks with single-stage regulators are available to complete your portable system. Includes high-pressure hoses and cylinder wrench.

For VMS®, VMS® Plus, VME2® and VMC, Five-Leg Base (Not for use on VME™)

93305369	1 Cylinder O ₂ (USA)	\$601.00
94305370	2 Cylinders O ₂ (USA)	\$784.00
65932200	Replacement "T" Handle	\$18.00
91120014	"E" or "D" Cylinder Seals, pkg. of five	\$63.00



93305369 for (1) O₂



94305370 for (2) O₂



91120014

Maintenance Kit

All the parts you need for routine anesthesia machine maintenance in one convenient package—easy and affordable. Save money versus purchasing each item separately.

91303015	Maintenance Kit for Midmark VMS [®] , VMS [®] Plus, VMC	\$144.00
91303016	Maintenance Kit for Midmark VME [™] Stand Mount	\$227.00
91303017	Maintenance Kit for Midmark VME2 [®] , VME [™] Tabletop	\$109.00



91303015

Midmark Occlusion Valve with Safety Relief

The Midmark Occlusion Valve with Safety Relief Assembly allows you to simply and quickly close the breathing circuit to allow you to bag (sigh) the patient.

- Easily attaches to your Midmark anesthesia machine, no tools required
- Constructed of long-lasting anodized aluminum
- Safety relief feature (25-30 cm H₂O) prevents unsafe pressure build-up in the anesthesia circuit/patient
- Simply operated by the push of a single silicone activation button
- Included with each Midmark VMS[®] and VMS[®] Plus Anesthesia Machine

93805114	Occlusion Valve with Safety Relief	\$158.00
----------	------------------------------------	----------

Note: APL valve is NOT included

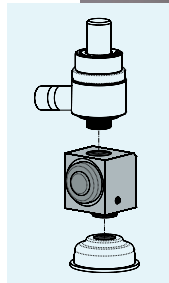

Occlusion Valve with Safety Relief attaches easily between the Midmark Exhalation Valve Dome and APL Valve as shown.

Absorber Quick Release Conversion Kit

Easily convert a thumb nut-style absorber to a convenient quick-release absorber. Simple flip-lever locking mechanism allows you to easily seal the absorber canister.

91800138	Quick Release Conversion Kit	\$191.00
----------	------------------------------	----------

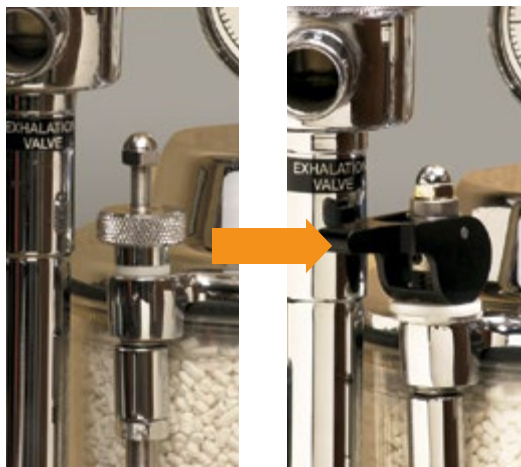

Go from a thumb nut-style absorber (left), to a quick-release absorber (right).

Oxygen Flowmeters

For VMS[®]/VMS[®] Plus/VME2[®]/VML[™]

Scale reads from 0.2 to 4 LPM for the VMS[®], VMS[®] Plus and VME2[®], and 1 to 10 LPM for the VML[™]. Dual-view flowmeters quickly switch from standard to magnified view at the touch of a finger.

VMS[®] O₂ Flowmeter Assembly with Flush
91800206 (USA) \$940.00
91800207 (ISO/Canada)

VMS[®] Plus/VME2[®] O₂ Flowmeter Assembly with Flush
91800203 (USA) \$940.00
91800204 (ISO/Canada)

VML[™] O₂ Flowmeter Assembly with Flush
91800254 (USA) \$940.00
91800255 (ISO/Canada)

Low Flow O₂ Kit
91800709 (USA) (0-1000cc) \$940.00



Standard View

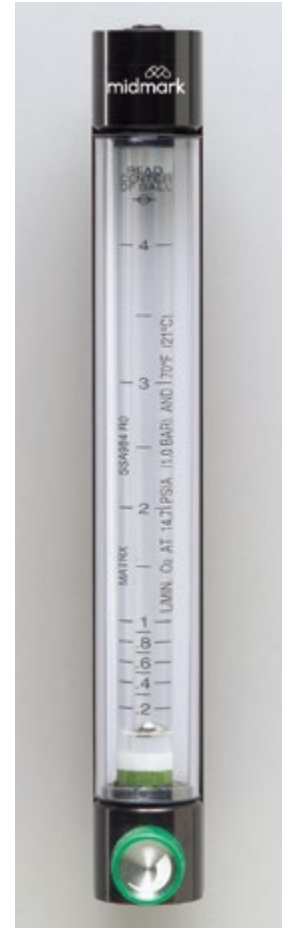

Magnified View

Ayres Non-rebreathing System with Scavenger Adapter

Connects in seconds to any Midmark anesthesia machine. Designed especially for the small animal patient with less than 15 lb (6.8 kg) body weight, it provides minimal dead space and less resistance to flow as compared to a full-circle system.

94515185 Ayres System Complete \$227.00

Replacement Parts

92305073	(A) FS-2 Outlet Adapter	\$51.00
91315075	(B) Black Rubber Tubing 7/16" OD x 1/4" ID hose Must order 48" length	\$0.30/in.
92315080	(C) "T" Tube Adapter	\$62.00
92316019	(D) Breathing Tube	\$61.00
92305098	(E) Bag to Tube Adapter	\$34.00
91800194	(F) 1L Bag with Scavenger Adapter	\$89.00
91305439	(G) Scavenger Adapter	\$61.00
91815246	(H) Tube Connector x 19 mm x 15 mm	\$35.00
92800173	1L Bag w/Hole, No Scav. Adapter	\$43.00

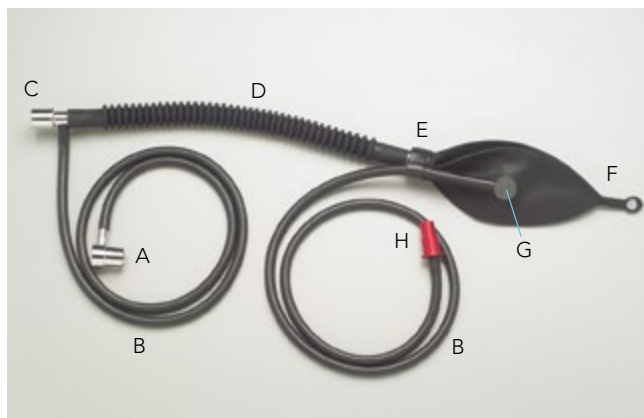

94515185

Breathing Circuits

Designed to maximize patient safety and user convenience. A 360-degree connector rotation eliminates tubing twists or kinks. Advanced Z-wave tubing provides superior flexibility.

002-1705-00	22 mm Diameter	\$26.00
91316419	15 mm Diameter w/1-Liter Breathing Bag	\$32.00



91316419



002-1705-00

Unilimb Rebreathing Circuit

Innovative tube-within-a-tube design enhances performance and convenience.

- Aids in heat and moisture retention, speeding patient recovery time
- Efficient design reduces clutter of multiple tubes

91316417	Unilimb Rebreathing Circuit 40"	\$34.00
91316431	Unilimb Rebreathing Circuit 60"	\$35.00
91316432	Unilimb Rebreathing Circuit 72"	\$36.00
91316435	Pediatric Unilimb Rebreathing Circuit 40"	\$34.00



91316417

Midmark Veterinary Rubber Goods

(A) Corrugated Breathing Tubes

92316020	VMS [®] /VMC/VME [™] – 40" (102 cm)	\$72.00
20221100	* VML [™] – 72" (183 cm) Note: VML [™] breathing tube is semi-translucent, not black rubber.	\$134.00

(B) Black Tubing

91315075	7/16" OD x 1/4" ID (11 mm OD x 6 mm ID)	\$0.30/in.
91315076	1/2" OD x 5/16" ID (13 mm OD x 8 mm ID)	\$0.30/in.

(C) Breathing Bags

91316047	1/2 Liter	\$39.00
91316041	1 Liter	\$39.00
91316042	2 Liter	\$39.00
91316043	3 Liter	\$39.00
91316044	4 Liter	\$39.00
91316045	5 Liter	\$39.00
93815401	15 Liter*	\$481.00
93815400	30 Liter*	\$550.00

* 15 L and 30 L breathing bags and tubes for the VML[™] have a 2" (5 cm) ID opening.

(D) Breathing Circuit Accessories

91315088	VMS [®] /VMC/VME [™] Inhaler "Y"	\$6.00
93815403	VML [™] Inhaler "Y"	\$408.00
10008200	VML [™] Inhaler "Y" Retaining Ring (Included with 93815403)	\$123.00

(E) Straight Mask Adapter

91315091	15 mm – 22 mm	\$67.00
----------	---------------	---------

VML[™] Endo Tube Connectors

92805421	22 mm	\$72.00
92805425	25 mm	
92805434	30 mm	
92805435	40 mm	

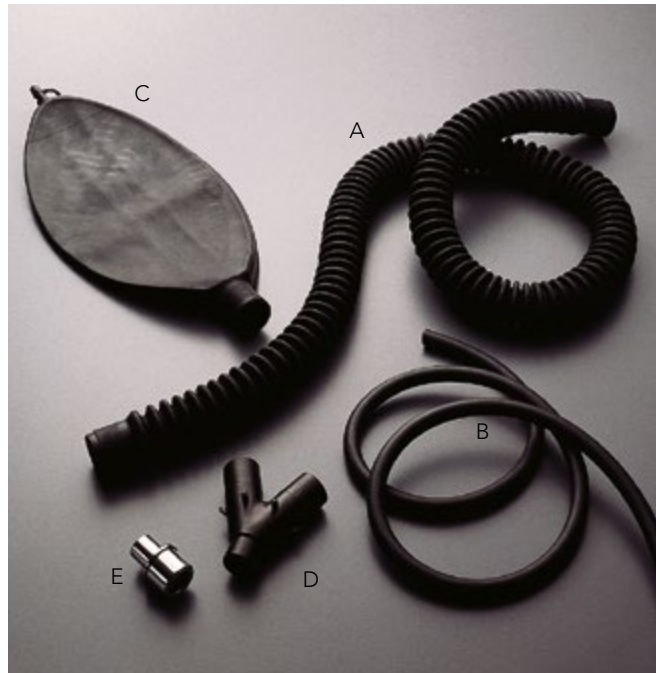

Midmark Hose Assemblies

Quality color-coded, nylon-reinforced hoses with chrome-plated brass fittings.

O₂ Hose Assembly

- 92305126* Female DISS x Ohio Male QC (USA)
\$88.00 + \$2.50/ft.
- 92305291* Female DISS x Ohio Male QC (ISO)
\$88.00 + \$2.50/ft.
- 92305110* Female DISS x Female DISS (USA)
\$78.00 + \$2.50/ft.
- 92305297* Female DISS x Female DISS (ISO)
\$78.00 + \$2.50/ft.
- 92305118* Female DISS x Ohio Female QC (USA)
\$146.00 + \$2.50/ft.

N₂O Hose Assembly

- 92305127* Female DISS x Ohio Male QC (USA/ ISO)
\$88.00 + \$2.50/ft.
- 92305111* Female DISS x Female DISS (USA/ ISO)
\$78.00 + \$2.50/ft.

*SPECIFY HOSE LENGTH

Midmark hoses are available in the lengths below. All measurements are in feet. Please specify hose length when placing your order.

- 92305110: 1-12, 15, 16, 20, 24, 25, 30, 50
- 92305111: 1-12
- 92305118: 1-12, 15, 20
- 92305120: 1-12, 15
- 92305121: 1-12
- 92305122: 1-12, 20
- 92305124: 1-12
- 92305125: 1-12
- 92305126: 1-13, 15, 16, 18, 20, 25
- 92305127: 1-13, 15, 16
- 92305128: 1-12
- 92305288: 1-12, 24
- 92305291: 1-13, 16
- 92305297: 1, 3, 6, 10

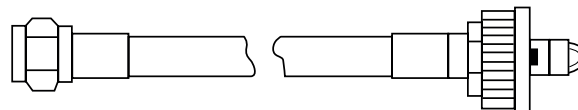

- Female DISS x Ohio Male QC
- 92305126 (O₂) \$88.00 + \$2.50/ft.
 - 92305127 (N₂O) \$88.00 + \$2.50/ft.

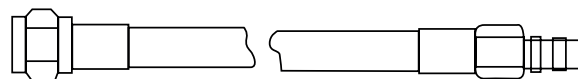

- DISS Female x Puritan Male
- 92305122 (O₂) \$196.00 + \$2.50/ft.

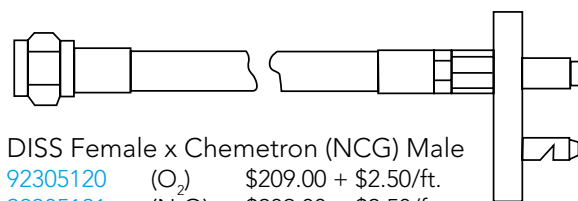

- DISS Female x Chemetron (NCG) Male
- 92305120 (O₂) \$209.00 + \$2.50/ft.
 - 92305121 (N₂O) \$209.00 + \$2.50/ft.



- DISS Female x Schrader Male
- 92305124 (O₂) \$149.00 + \$2.50/ft.
 - 92305125 (N₂O) \$149.00 + \$2.50/ft.

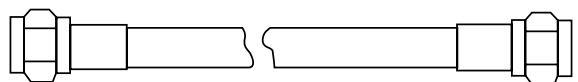

- DISS Female x DISS Female
- 92305110 (O₂) \$78.00 + \$2.50/ft.
 - 92305111 (N₂O) \$78.00 + \$2.50/ft.

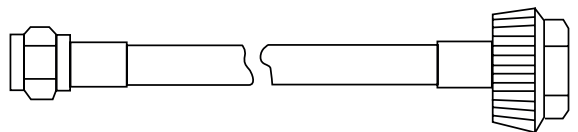

- DISS Female x Hand-I-Twist DISS Female
- 92305288 (O₂) \$81.00 + \$2.50/ft.

Scavengers

Veterinary Anesthetic Gas Scavenger

The Midmark Veterinary Anesthetic Gas Scavenger offers reliable active scavenging of waste anesthetic gas. It is available in a post-mount or wall-mount configuration. Each wall- or post-mount scavenger unit will scavenge the waste anesthetic gas from one anesthesia machine.

- For maximum flexibility, the post-mount scavenger comes complete with 20 ft (6 m) of 32 mm tubing, 5 ft. (1.5 m) of 19 mm tubing and post-mount hardware
- The wall-mount scavenger comes complete with 2 ft (0.6 m) of 32 mm tubing, 18 ft (5.5 m) of 19 mm tubing and wall-mount hardware.
- Replace charcoal canisters forever with an active gas scavenging system that quietly and consistently keeps you safe
- Available in post mount or wall-mount configurations
- Quiet operation
- Can be used with a ventilator or oxygenator
- Easy to install, compact design with few parts
- Standard 19 mm inlet connection
- Power on/off switch with indicator light
- Low voltage (12V DC) operation

91515178	Post-Mount Veterinary Scavenger (1.75" diameter fittings will fit most stand-mounted anesthesia machines)	\$1,358.00
91515181	Post-Mount Veterinary Scavenger (Euro-230V/50Hz)	\$1,358.00
91515179	Wall-Mount Veterinary Scavenger	\$1,358.00
91515182	Wall-Mount Veterinary Scavenger (Euro-230V/50Hz)	\$1,358.00
91515169	Post-Mount Replacement Tubing Kit	\$211.00
91515170	Wall-Mount Replacement Tubing Kit	\$89.00
65939600	Scavenging Hose, 19 mm ID (Please order in 12" increments.)	\$0.30/in.
65939700	Scavenging Hose, 32 mm ID	\$0.30/in.

Scavenger Interface

94805173	Scavenger Interface Without Mount	\$2,544.00
94805172	Scavenger Interface Column Mount	\$2,544.00



Portable-Post Mount 91515178



Wall Mount 91515179

Midmark Central Scavenger

The Midmark Central Scavenger safely removes waste gas from your clinic without the cost or hassle of charcoal canister replacement.

- Replace charcoal canisters forever with an active gas scavenging system that quietly and consistently keeps you safe
- Scavenge waste gas from up to four anesthesia machines
- Easily expand the system to cover up to 12 anesthesia machines without significant expense
- Keep your clinic neat and tidy without bulky interface devices attached to the anesthesia machines
- Simple installation process and flexible design ensures your scavenging system will be successfully installed
- Unparalleled service and support to give you peace of mind

40162800	Midmark Central Scavenger (for up to four anesthesia machines)	\$2,313.00
20236000	Expansion Kit (for up to four additional anesthesia machines)	\$543.00



This product has limited availability outside of the US. For confirmation, please contact Midmark Customer Experience.

Ventilators

Model 3002PRO Small Animal Anesthesia Ventilator

An electronically controlled, time-cycled, pressure-limited ventilator, the Model 3002PRO replaces the breathing bag to provide smooth, even delivery of anesthesia. Designed specifically for veterinary practice, the 3002PRO assures a constant volume for each delivered breath, regardless of patient compliance and airway resistance. Easy-to-use controls make operation simple and convenient.

- Replaces the breathing bag
- Single volume control knob allows for minute changes with small patients
- Promotes regular breathing for a smoother plane of anesthesia, more normocapnic PaCO₂ levels and a more normal blood pH
- More economical use of supply gas (oxygen or clean dry air)
- Interchangeable bellows adapt to animals from 2.2 lb to 440 lb (1 kg to 200 kg)—no tools required
- Maximum working pressure limit (MWPL) adjustable from 10-60 cm H₂O
- Dual-airway pressure alarms monitor the peak inspiratory pressure (PIP) of every breath and sound when the PIP either exceeds the preset maximum working pressure limit (MWPL), or fails to reach 6 cm H₂O as in the case of a disconnect
- Standard low-supply gas alarm signals when supply-gas pressure falls below 35 psi
- Adapts easily to all anesthesia circuits with out-of-circuit vaporizers
- Accommodates respiratory rates from 6-40 breaths per minute at inspiratory flow rates from 0-100 LPM
- Built-in scavenging port
- Deliverable tidal volume (TV) range is from approximately 20 cc to 3,000 cc



Note: All versions of the Model 3002PRO Anesthesia Ventilator include Model 3002PRO controller, bellows base assembly, pressure-sensing tube and tee, driving gas tube, power cord, spare fuse and operating manual.

Note: For ease of installation, use an existing gas supply as the driving gas. Please order one demand wye and supply hose.

91806001	Model 3002PRO with 300–1600 ml bellows and bellows housing Approx. Patient Weight Range 44–264 lb (20–120 kg)	\$6,303.00
91806002	Model 3002PRO with 0–300 ml bellows, bellows housing and adapter Approx. Patient Weight Range Up to 55 lb (0–25 kg)	\$6,483.00
91806005	Model 3002PRO with 300–1600 ml bellows and bellows housing plus 0–300 ml bellows, bellows housing, and adapter	\$7,014.00

Demand Wye

91806022	DISS O ₂ , Green	\$146.00
91806029	DISS O ₂ , White	\$146.00

Supply Hose

91806031	DISS O ₂ , FxF, 4 ft., Green	\$107.00
91806032	DISS O ₂ , FxF, 4 ft., White	\$107.00

Ventilator Accessories

Bellows

91806021	0-300 ml Attachment (Includes: Bellows, Adapter and Housing)	\$896.00
91806026	(A) 0-300 ml Bellows	\$363.00
91806027	(B) 0-300 ml Bellows Adapter	\$200.00
91806028	(C) 0-300 ml Bellows Housing	\$440.00
91806042	300-1600 ml Bellows	\$407.00
91806044	300-1600 ml Bellows Housing	\$459.00
91806043	1600-3000 ml Bellows	\$489.00
91806045	1600-3000 ml Bellows Housing	\$725.00

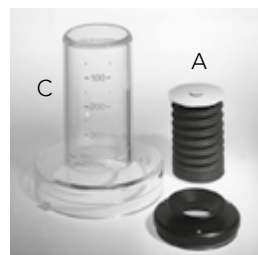

Demand Wye

91806022	(D) DISS O ₂ , Green	\$146.00
91806029	(E) DISS O ₂ , White (Int'l Version)	\$146.00
91806023	(F) DISS O ₂ 90°, Green	\$174.00
91806030	(G) DISS O ₂ 90°, White (Int'l Version)	\$174.00

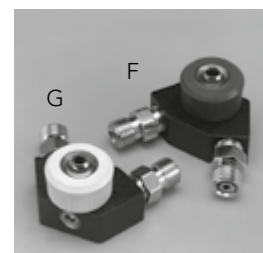
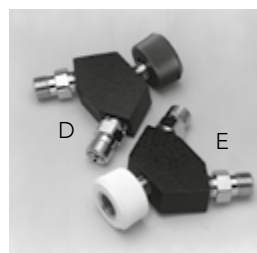

Supply Hose

91806031	(H) DISS O ₂ , FxF, 4 ft., Green	\$107.00
91806032	(I) DISS O ₂ , FxF, 4 ft., White (Int'l Version)	\$107.00

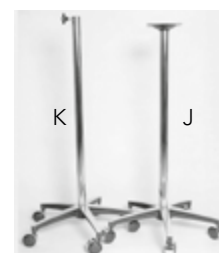
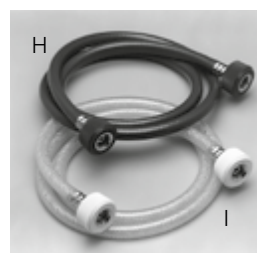

Stands

91806033	(J) 5 Leg, 42" w/Casters and Mounting Plate	\$442.00
91806034	(K) 5 Leg, 37" w/Casters and Bushing Mount	\$432.00

Mounting Arms/Plates

91805151	Mounting Arm w/Plate for VMC	\$449.00
91805152	Mounting Arm w/Plate and Extension for VMS®	\$338.00
93805128	Mounting Plate	\$156.00
91805154	Mounting Arm	\$103.00
91805155	Mounting Arm Extension	\$145.00



91805152

Replacement Parts

91806038	(M) O-Ring, Base to Housing	\$45.00
91806039	(N) O-Ring, Bellows Adapter	\$33.00
91806040	(P) O-Ring, Base to Pop-Off Valve	\$22.00
91806048	Pressure Sampling Tee	\$72.00
91806049	Clear Corrugated Tubing 22 mm x 36"	\$13.00

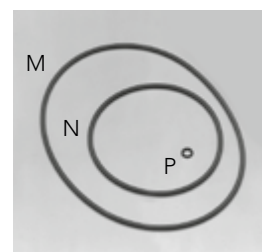

Fluid Warming

Midmark IV Fluid Warmer

The IV Fluid Warmer is designed to help reduce the risk of hypothermia during anesthesia.

- Portable and lightweight
- Temperature displayed in degrees Fahrenheit or Celsius
- Temperature overheating protection
- Single IV routing option allows for quick and easy setup
- Compatible with standard IV sets
- LED Display
- Convenient hanging belt and clamp
- Not recommended for use with blood products
- 1-year limited warranty



VF-5 Midmark IV Fluid Warmer \$509.00

NOTE: This product has limited availability outside of the U.S. For confirmation, please contact Midmark Customer Experience.

Anesthesia Accessories

Small Animal Anesthesia Masks

Available in sizes to fit all feline and canine patients, these high-quality plastic masks feature a 15 mm connector, clear cone for full visualization, and a highly flexible, replaceable rubber diaphragm designed to minimize leaks.



Masks with Diaphragm

91351400	Set of 5 Masks (1each of below)	\$287.00
93805027	Small Feline Mask	\$53.00
93805028	Medium Feline Mask	\$53.00
93805029	Large Feline Mask	\$53.00
93815026	Small Canine Mask	\$61.00
93815028	Large Canine Mask	\$61.00

Mask	Outer Dia.	Inner Dia.	Cone Depth
Small Feline	1-3/4" (44 mm)	7/8" (22 mm)	15/16" (24 mm)
Medium Feline	2-1/4" (57 mm)	1-3/16" (30 mm)	1-1/8" (29 mm)
Large Feline	2-3/8" (60 mm)	1-5/16" (33 mm)	1-3/8" (35 mm)
Small Canine	3-7/16" (87 mm)	1-3/16" (30 mm)	2-7/8" (73 mm)
Large Canine	5-1/8" (130 mm)	2-1/8" (54 mm)	4-3/4" (121 mm)

Replacement Diaphragms

91815014	Small Feline	\$34.00
91815015	Medium Feline	\$34.00
91815016	Large Feline	\$34.00
91815017	Small Canine	\$34.00
91815018	Large Canine	\$34.00

Sterile Endotracheal Tubes

Superior cuff design helps you prepare for correct intubations every time. The thin, large diameter cuff conforms to uneven tracheal surfaces and maintains a proper low-pressure seal. A high-compliance cuff lies close to the tube, improving visualization prior to inflation.

Cuffed Endotracheal Tubes

91316537	(3.0 mm)	\$5.00
91316551	(3.5 mm)	
91316538	(4.0 mm)	
91316539	(4.5 mm)	
91316540	(5.0 mm)	
91316541	(5.5 mm)	
91316542	(6.0 mm)	
91316543	(6.5 mm)	
91316544	(7.0 mm)	
91316545	(7.5 mm)	
91316546	(8.0 mm)	
91316547	(8.5 mm)	
91316548	(9.0 mm)	
91316549	(9.5 mm)	
91316550	(10.0 mm)	

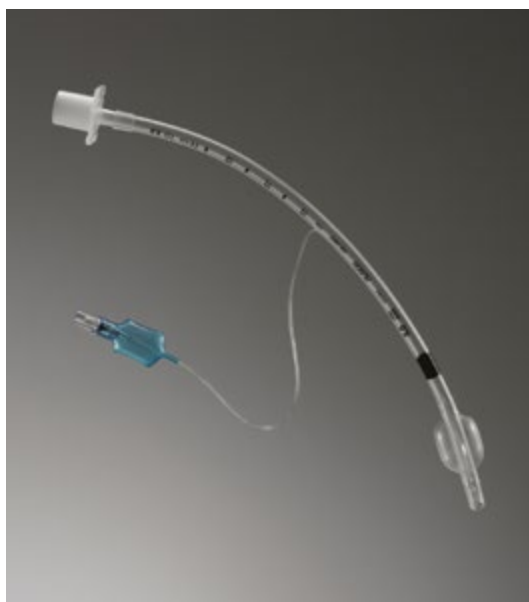

Cuffed

Uncuffed Endotracheal Tubes

91316526	(2.0 mm)	\$5.00
91316527	(2.5 mm)	
91316528	(3.0 mm)	
91316529	(3.5 mm)	
91316530	(4.0 mm)	
91316531	(4.5 mm)	
91316532	(5.0 mm)	
91316533	(5.5 mm)	
91316534	(6.0 mm)	
91316535	(6.5 mm)	
91316536	(7.0 mm)	



Uncuffed

Frosted Halogen Laryngoscope Blades

- 93315450 (A) Macintosh Size 1 (87 mm) \$98.00
- 93315451 (B) Macintosh Size 2 (108 mm)
- 93315452 (C) Macintosh Size 3 (128 mm)
- 93315453 (D) Macintosh Size 4 (159 mm)
- 93315468 (E) Miller Size 0 (75 mm)
- 93315469 (F) Miller Size 1 (102 mm)
- 93315470 (G) Miller Size 2 (155 mm)
- 93315471 (H) Miller Size 3 (195 mm)
- 93315472 (I) Miller Size 4 (205 mm)

Laryngoscope Handles and Bulbs

Designed to accept both Macintosh and Miller blades. Handles are available in a choice of two sizes. Chrome-plated stainless steel construction.

- 91315278 Standard – accepts 2 "C" size batteries \$63.00
- 020-0354-00 Short handle – accepts 2 "AA" size batteries \$65.00
- 002-1962-00 Small Replacement Lamps, 5 pk Fits Macintosh 1 & 2, Miller 1, 2, & 3 \$46.00
- 002-1961-00 Large Replacement Lamps, 5 pk Fits Macintosh 2, 3, & 4, Miller 3 & 4 \$35.00

Disposable LED Laryngoscope Blade Kit

System features interchangeable, disposable laryngoscope blades with a medium reusable handle. The disposable stainless steel blades are offered in Macintosh sizes 2, 3 and 4 as well as Miller sizes 0,1, 2 and 3.

- 91315601 Disposable Blade Kit with Reusable Handle \$259.00

Disposable Laryngoscope Blades

- 91315602 Disposable Size 2 Macintosh Blade, each \$22.00
- 91315603 Disposable Size 3 Macintosh Blade, each
- 91315604 Disposable Size 4 Macintosh Blade, each
- 91315605 Disposable Size 0 Miller Blade, each
- 91315606 Disposable Size 1 Miller Blade, each
- 91315607 Disposable Size 2 Miller Blade, each
- 91315608 Disposable Size 3 Miller Blade, each



Emergency Response Kits

Emergency Response Kits are available in two sizes and contain a Disposable Resuscitator, Animal Mask Kit, Oxygen Supply Tubing, Physiological Parameter List and Carry Case.

90000	Small Emergency Response Kit For animals weighing less than 66 lb (30kg)	\$329.00
90001	Large Emergency Response Kit For animals weighing 66 lb (30kg)	\$329.00
91351400	Replacement Mask Set (Includes 1 each: small feline, medium feline, large feline, small canine and large canine mask)	\$287.00
91150010	Oxygen Supply Tubing (7 feet)	\$2.00



LSP Disposable Resuscitator

Reliable, efficient ventilation with patient protection. Features non-deforming bag, pressure relief valve on Small and X-Small models, and connector for optional pressure-manometer or PEEP valve. Includes mask, oxygen supply tubing and oxygen reservoir. Not made with natural rubber latex.

91350666	Large (patients over 55 lb/25 kg) Disposable BVM w/Bag Reservoir	\$48.00
91350667	Small (patients between 16 and 55 lb/7.3-25 kg) Disposable BVM w/Bag Reservoir	\$48.00
91350668	X-Small (patients less than 16 lb/7.3 kg) Disposable BVM w/Bag Reservoir	\$48.00



Mayo Tray Cart

91805145	Mayo Tray Cart w/2 trays	\$723.00
91805146	Mayo Tray (1)	\$65.00



Boarding + Containment

Midmark boarding and containment offers the flexibility you need for your clinic, shelter or animal care facility. Our variety of kennel door designs, modular cage units and stylish condos help improve workflow while achieving the look and functionality you desire.



DOG SOLUTION

Stainless-Steel Cages

Midmark stainless steel cages are manufactured with many features that enhance cleanability, strength and ease-of-use.

- Patient comfort enhancements added to single door latch and all cage bodies for a 19% noise reduction
- All 20-gauge 304 stainless steel construction—23% thicker than industry average
- Heavy-duty reversible door
- One-piece stainless steel hinge plate with multiple attachment points for stability and to help prevent sagging
- Stainless steel door features 3/8" diameter frame, 1/4" diameter crossmembers and 3/16" diameter vertical rods
- One-piece stainless steel corner/trim strips to enhance strength and stability
- Full 1" radiused corners
- Heavy-gauge latch—padlock or door clip—extremely quiet, yet secure and easy to open and close
- Fluid-retaining lip and larger radiused corners with a cleaner kennel environment



261-0001-00 Cage Bank, 3 Unit Option 1 \$3,974.00
Includes 48" mobile base, Left and Right 30" side panels and 48" top panel

SINGLE DOORS

160-1824-00	Single Door 18" w x 24" h x 28" d	\$624.00
160-2418-00	Single Door 24" w x 18" h x 28" d	\$624.00
160-2424-00	Single Door 24" w x 24" h x 28" d	\$641.00
160-2430-00	Single Door 24" w x 30" h x 28" d	\$759.00
160-3024-00	Single Door 30" w x 24" h x 28" d	\$759.00
160-3030-00	Single Door 30" w x 30" h x 28" d	\$860.00
160-3630-00	Single Door 36" w x 30" h x 28" d	\$902.00

NOTE: Actual single cage heights including top and bottom flanges:
18" = 20.25", 24" = 26.25", 30" = 32.25", 36" = 38.25"

DOUBLE DOORS

160-4830-00	Double Door 48" w x 30" h x 28" d w/ Spring Loaded Latch	\$1,306.00
160-4830-01	Double Door w/ Gravity Latch 48" w x 30" h x 28" d, Non- Removable Center Trim Piece	\$1,306.00
160-4836-00	Double Door w/ Gravity Latch 48" w x 36" h x 28" d, Non- Removable Center Trim Piece	\$1,420.00

NOTE: Actual single cage heights including top and bottom flanges:
18" = 20.25", 24" = 26.25", 30" = 32.25", 36" = 38.25"



Configure Your Stainless-Steel Cage Bank Online

Select an assembly width and browse through the options to find the configuration that fits your needs. Visit: midmark.com/animal-health/design-center/cage-bank-configurator

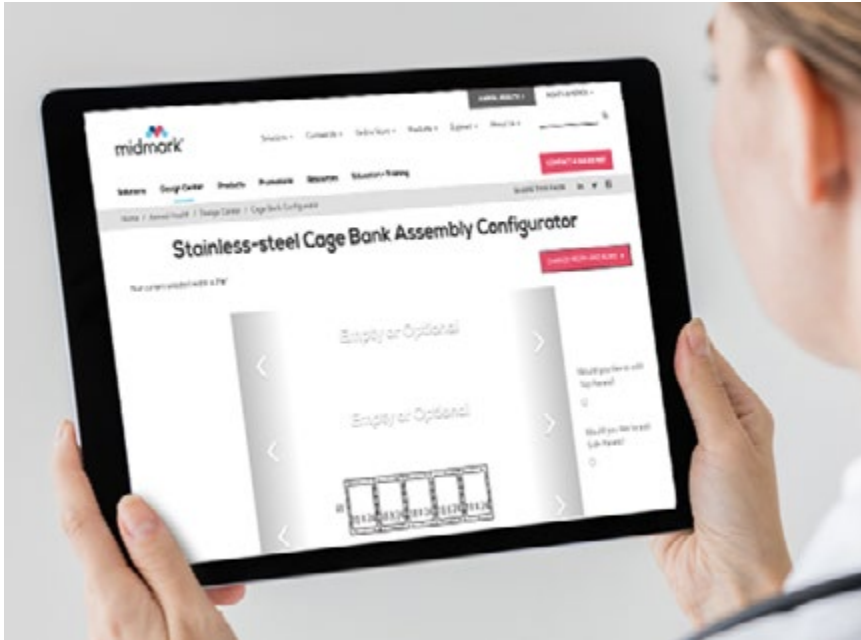

LET'S DESIGN YOUR CONTAINMENT SPACE, TOGETHER!

Early in the process, we'll work with your team to discuss goals, measure and evaluate your space, and recommend an optimal design to suit your needs. This will help you avoid costly mistakes and ensure that your containment configurations are appropriate for your boarding kennel space and your business objectives.



NOTE: For ordering information or to ask about part number items shown above, contact us at 1.800.299.9525.

[Back to Contents](#)

STAINLESS-STEEL CAGE ACCESSORIES

TOP PANEL

619-0368-00	Top Panel for 18" w Cage Bank	\$112.00
619-0368-01	Top Panel for 24" w Cage Bank	\$130.00
619-0368-02	Top Panel for 30" w Cage Bank	\$147.00
619-0368-03	Top Panel for 36" w Cage Bank	\$156.00
619-0368-04	Top Panel for 48" w Cage Bank	\$208.00
619-0368-05	Top Panel for 60" w Cage Bank	\$323.00
619-0368-06	Top Panel for 72" w Cage Bank	\$348.00



STATIONARY PLATFORM

260-0359-00	18" w Stationary Platform	\$149.00
260-0359-01	24" w Stationary Platform	\$159.00
260-0359-02	30" w Stationary Platform	\$169.00
260-0359-03	36" w Stationary Platform	\$176.00
260-0359-04	48" w Stationary Platform	\$244.00
260-0359-05	60" w Stationary Platform	\$270.00
260-0359-06	72" w Stationary Platform	\$312.00



MOBILE PLATFORM

260-0359-20	18" w Mobile Platform	\$202.00
260-0359-21	24" w Mobile Platform	\$212.00
260-0359-22	30" w Mobile Platform	\$224.00
260-0359-23	36" w Mobile Platform	\$231.00
260-0359-24	48" w Mobile Platform	\$296.00
260-0359-25	60" w Mobile Platform	\$323.00
260-0359-26	72" w Mobile Platform	\$373.00



SIDE PANEL

619-0342-00	Side Panel for 18" h Cage, Right	\$127.00
619-0343-00	Side Panel for 18" h Cage, Left	\$127.00
619-0344-00	Side Panel for 24" h Cage, Right	\$149.00
619-0345-00	Side Panel for 24" h Cage, Left	\$149.00
619-0346-00	Side Panel for 30" h Cage, Right	\$161.00
619-0347-00	Side Panel for 30" h Cage, Left	\$161.00
619-0348-00	Side Panel for 36" h Cage, Right	\$174.00
619-0349-00	Side Panel for 36" h Cage, Left	\$174.00



STAINLESS-STEEL CAGE ACCESSORIES

OXYGEN THERAPY DOOR

145-2424-00	O ₂ Therapy Door for 24" w x 24" h Cage	\$668.00
145-2430-00	O ₂ Therapy Door for 24" w x 30" h Cage	\$690.00
145-3030-00	O ₂ Therapy Door for 30" w x 30" h Cage	\$707.00
145-3630-00	O ₂ Therapy Door for 36" w x 30" h Cage	\$734.00



CENTER DIVIDER KIT

260-4830-20	Center Divider Kit, 30" h Standard Latch Doors (shown)	\$262.00
260-4830-21	Center Divider Kit, 30" h Gravity Latch Doors	\$349.00
260-4836-21	Center Divider Kit, 36" h Gravity Latch Doors, (160-4836-00 cage only)	\$271.00



PVC-COATED CAGE FLOORS

616-0208-00	Coated Floor 24" Wide Cage 21-3/8" w x 3 -3/16" h x 27-11/16" d	\$216.00
616-0209-00	Cage Floor for 30" Cage 27-3/8" w x 3-3/16" h x 27-11/16" d	\$241.00
616-0210-00	Cage Floor for 36" Cage 33-3/8" w x 3-3/16" h x 27-11/16" d	\$269.00
616-0207-00	Cage Floor for 18" Cage 15-3/8" w x 3-3/16" h x 27-11/16" d	\$193.00



HINGE-MOUNTED IV ROD

620-0362-00	IV Rod	\$104.00
-------------	--------	----------



ACCESSORIES

834-0000-06	1 Pint Stainless Steel Bowl	\$10.00
834-0000-10	1 Quart Stainless Steel Bowl	\$11.00
834-0000-20	2 Quart Stainless Steel Bowl	\$12.00
260-0377-06	S.S. Bowl Bracket, 1 pint	\$31.00
260-0377-10	S.S. Bowl Bracket, 1 quart	\$31.00
260-0377-20	S.S. Bowl Bracket, 2 quart	\$32.00
260-0500-01	S.S. Clipboard 5 1/2" x 7 1/2"	\$22.00
260-0500-02	S.S. Clipboard 9" x 12"	\$25.00
260-0503-00	Clear, polyvinyl accessory box	\$66.00

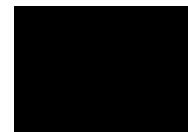

DOG SOLUTION

Fiberglass Quiet Cottages

A warmer, quieter alternative to standard cage banks.

Manufactured with durable fiberglass materials, Quiet Cottages create a warmer, quieter environment for dogs. The unique design also offers flexibility to support your canine population: Each 4' unit includes double doors for easier handling of large canines, as well as a removable panel that allows you to convert the unit into two smaller 2' cages.

Available in a variety of configurations, door types, and exterior colors, you can create the perfect environment for your canine friends.

Color-Specific Part Number Example:

QM03-LN-337

1 2 3 4 5

NOTE: To order, please provide a complete configuration that includes a selection from each of the numbered areas.

1 PRODUCT CODE

QM Quiet Cottage

2 MODEL CONFIGURATION

		w/o Heat	with Heat
01	84" Wide 5 Unit	\$11,175.00	\$16,698.00
02	84" Wide 6 Unit	\$11,321.00	\$17,809.00
03	28" Wide 2 Unit	\$4,805.00	\$7,134.00
04	36" Wide 2 Unit	\$5,084.00	\$7,435.00
05	48" Wide 2 Unit	\$7,175.00	\$9,729.00
06	56" Wide 4 Unit	\$7,893.00	\$12,301.00
07	72" Wide 4 Unit	\$8,472.00	\$12,924.00
08	64" Wide 4 Unit	\$8,193.00	\$12,624.00
09*	36" Wide 3 Unit	\$9,590.00	n/a
10*	36" Wide 2 Unit	\$6,532.00	n/a
11*	47" Wide 2 Unit	\$8,372.00	n/a
12	64" Wide 4 Unit	\$9,593.00	n/a
13	48" Wide 4 Unit	\$8,674.00	\$13,061.00
14	72" Wide 6 Unit	\$12,469.00	\$18,924.00
16	24" Wide 2 Unit	\$5,191.00	\$7,509.00
17	48" Wide 3 Unit	\$7,224.00	\$10,645.00
18	72" Wide 5 Unit	\$11,702.00	\$17,193.00
19	72" Wide 4 Unit	\$8,992.00	\$13,481.00
20	72" Wide 5 Unit	\$10,528.00	\$15,982.00
21	64" Wide 4 Unit	\$8,280.00	\$12,711.00
22	52" Wide 4 Unit	\$8,272.00	\$12,616.00
23	30" Wide 2 Unit	\$4,955.00	\$7,252.00
24	54" Wide 4 Unit	\$8,442.00	\$12,809.00
25	58" Wide 4 Unit	\$8,042.00	\$12,419.00
26	60" Wide 4 Unit	\$8,294.00	\$12,676.00
27	66" Wide 4 Unit	\$8,363.00	\$12,762.00
28	84" Wide 6 Unit	\$11,802.00	\$18,253.00

3 DOOR TYPE

L Left Hand Door
R Right Hand Door

4 ACCESSORY

N No Heat Pad
P With Heat Pad

5 EXTERIOR COLOR

316 Aurora
337 White
671 Pearl
885 Steel Gray Granite
886 Scrimshaw
887 Cool Gray



Steel Gray
Granite-885



Cool Gray-887



Pearl-671

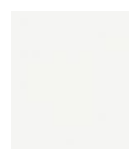

White-337



Scrimshaw-886

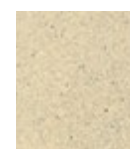

Aurora-316

*Drain included in configuration and no mobile platform

DOG SOLUTION

Fiberglass Drying Cages

Available as an accessory to Quiet Cottage models.

The blower operates on a standard 110-volt current, with a built-in timer that powers off the unit when the selected time elapses. Cleanable filters can be removed or installed without the need for additional tools. Hoses have blast-gates that open and close from the outside to allow easy access and support better safety for pets.

Color-Specific Part Number Example:

DM03-L-337

- 1
- 2
- 3
- 4

NOTE: To order, please provide a complete configuration that includes a selection from each of the numbered areas.

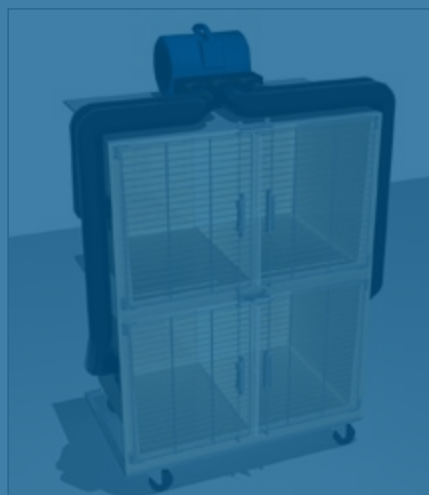

DISCONTINUED

- 1 PRODUCT CODE**
DM Dryer Unit
- 2 MODEL CONFIGURATION**
03 28" Wide 2 Unit
04 36" Wide 2 Unit
05 48" Wide 2 Unit (Double Doors only)
- 3 DOOR TYPE**
L Left Hand Door
R Right Hand Door
- 4 EXTERIOR COLOR**
316 Aurora
337 White
671 Pearl
885 Steel Gray Granite
886 Scrimshaw
887 Cool Gray

Model 3	Dryer unit - Model 03	\$5,295.00
Model 4	Dryer unit - Model 04	\$5,574.00
Model 5	Dryer unit - Model 05	\$7,666.00



Steel Gray-885



Cool Gray-887



Pearl-671



White-337



Scrimshaw-886

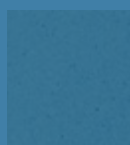

Aurora-316

DOG SOLUTION

Dog Daycare Room Dividers

Dog Daycare Room Dividers from Midmark create customized spaces and flexible room dimensions. Popular in doggie day care, this mobile panel system can be moved around the room as needed to create flexible play spaces, which can be ideal for separating larger and smaller dogs during open play time. Isolation panels can be constructed with pet safe materials using FRP or Wilsonart® in any size, shape or dimension. They can be built with a door to easily allow staff access to either side of the play areas. Additionally, the divider panels are on casters, making it easy to wheel them into multiple configurations. The result is a colorful, economical way to divide spaces without requiring permanent walls.

Call for 1.800.543.5567 for a quote!

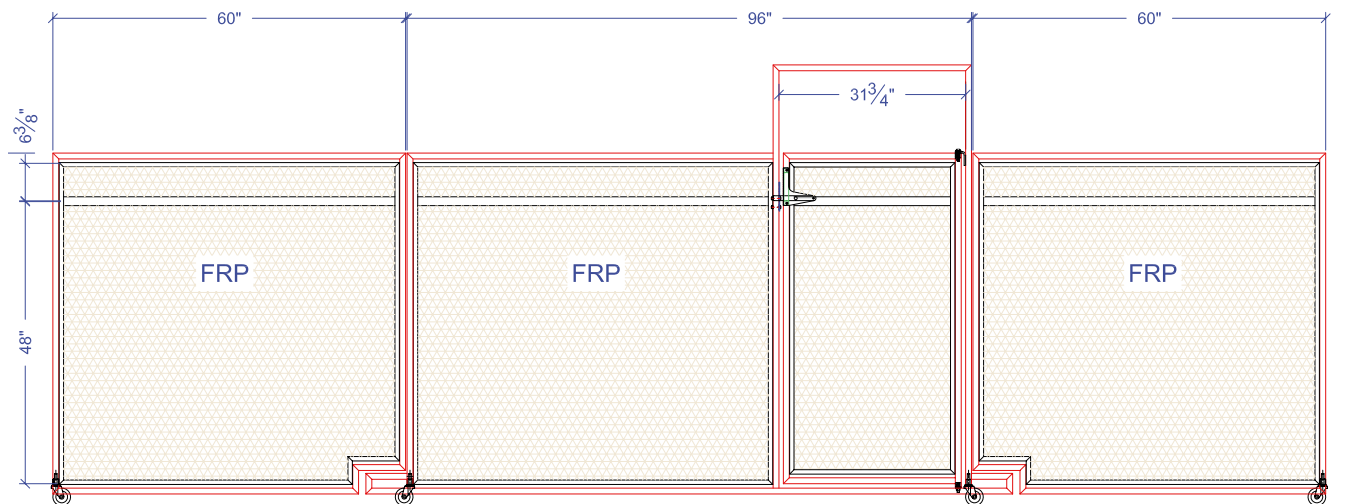

DOG SOLUTION

Chain Link Runs

Made with Midmark's exceptional quality and workmanship, our chain link runs offer flexibility and value. Available as stand-alone units or to connect multiple runs, their modular construction allows you to build enclosures of nearly any size and configuration.

Electro-galvanized wire is woven in-house for a silky, smooth finish and hand-laced for a tight, taut finish without sharp edges or burs.

Durable yet economical, Midmark chain link is ideal for a variety of settings, from outdoor boarding runs to military and working-dog facilities.

Two wire gauges available: 9, 11
Two mesh sizes available: 1.5", 2"

Call for 1.800.543.5567 for a quote!



NOTE: For ordering information or to ask about part number items shown above, contact us at 1.800.543.5567.

[Back to Contents](#)

DOG SOLUTION

K-9 Cabin Double-Stacked System

Stacked systems double your capacity without occupying added floor space.

The K-9 Cabin Double-Stacked System maximizes the number of animals you can accommodate within your space. Unit dimensions are customizable, ensuring that you can create a containment space appropriate for your facility.

With a wide range of gate styles and material choices, units can be configured back-to-back or against a wall. Optional accessories include built-in food and water bowls.

CUSTOMIZABLE OPTIONS

Panels: Stainless Steel Panels, Wilsonart® Panels, FRP Panels

Gate Material: Tempered Glass, Stainless Steel Welded Wire

Gate Styles: Swing Gate

Accessories: Feeding & Water Systems

Call for 1.800.543.5567 for a quote!

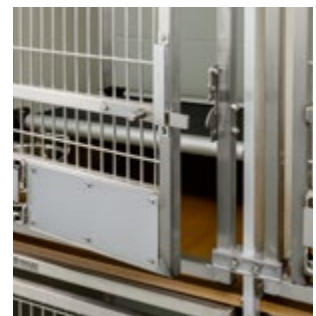

DOG SOLUTION

Luxury Walk-In Dog Suites

Luxury Dog Suites provide long-term or short-term living space for dogs.

Midmark's Luxury Walk-In Dog Suites provide all the functionality of a kennel without an institutional look. Rooms are more colorful and can be outfitted with beds, rugs, pictures and televisions for a living space or play area for dogs.

Additionally, a fixed piece next to the door can be solid glass or infilled with a variety of materials to create privacy. The door can be configured in the same manner as well to add privacy. The Luxury stall front can be configured with Midmark's Luxury Suite isolation panels or used with block wall or other materials.

Accessories not provided.

Call for 1.800.543.5567 for a quote!



DOG SOLUTION

Modular 2-Story Double-Deck Kennels

Double your revenue opportunity with a two-story kennel system.

If you're limited on floor space within your facility, you may be able to expand vertically. Midmark's patented Modular 2-Story Double-Deck™ Kennels create a second level of boarding runs with full-height, easy walk-in access for dogs and staff.

Engineered for flexibility, the Double-Deck System conforms to a wide range of building dimensions, enabling you to install the system in rooms as narrow as 18' with only 14' of interior headroom. The system features a complete plumbing and drainage system for the upper level and aisles. Stairways, provided by your vendor-of-choice, can be easily positioned in various locations.

Choose from back-to-back or single-row styles, with a variety of side panel styles, gates and accessories.

Call for 1.800.543.5567 for a quote!

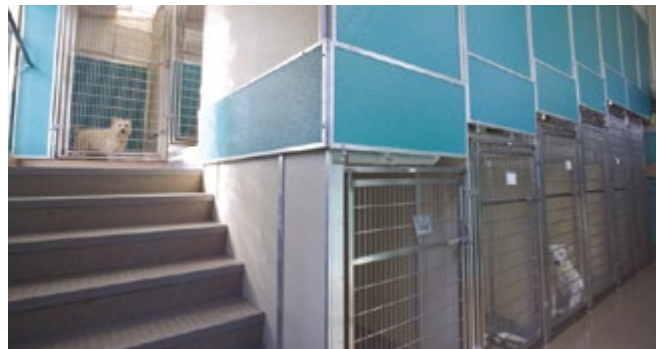

DOG SOLUTION

Sani-Kennels

Sani-Kennels are designed to look great while providing optimal comfort and safety for the animals in your care.

The Sani-Kennel system is a fully customizable modular kennel design that is easy to clean and attractive while maintaining effective airflow. With a wide range of panel sizes and designs to choose from, the system allows you to use existing facility floors, making it an ideal containment solution for a variety of animal care environments.

By combining the Sani-Kennel system with the patented Sani-Slope and Silvis Seal, you can achieve superior floor mounting and leveling within your facility.

PANEL OPTIONS: Stainless Steel Panels, Wilsonart® Panels, FRP Panels, Wire Mesh

GATE MATERIALS: Tempered Glass, Stainless Steel Welded Wire, or any combination with or without isolation

GATE STYLES: Swing Gate

ACCESSORIES: Transfer Doors, Rest Benches, Top Covers, Raised Floors, Gate Tops, Feeding and Water Systems



Call for 1.800.543.5567 for a quote!

10010754-XXX	3' Sani-Kennel, Solid FRP Back panel, Color of choice	\$704.00
10010755-XXX	4' Sani-Kennel, Solid FRP Back panel, Color of choice	\$824.00
10010751-XXX	4' Sani-Kennel, FRP Side panel with wire, Color of choice	\$850.00
10010752-XXX	5' Sani-Kennel FRP Side panel with wire, Color of choice	\$1,007.00
10010753-XXX	6' Sani-Kennel FRP Side panel with wire, Color of choice	\$1,146.00

"XXX" denotes color choices, as seen to the right.

SANI-KENNEL DOORS

10010756	3' Standard Run Door, S.S.	\$933.00
10010758	4' Standard Run Door, S.S.	\$1,219.00
10010757	3' Standard Run Door, Glass	\$989.00
10010759	4' Standard Run Door, Glass	\$1,281.00



875
Blue



255
Sage

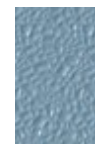

245
Sky



671
Pearl



878
Beige

NOTE: For ordering information or to ask about part number items shown above, contact us at 1.800.543.5567.

[Back to Contents](#)

Silvis Seal™ + Sani-Slope™

Superior floor mounting AND leveling solution exclusively from Midmark.

Available only on Midmark's Sani-Kennel™ systems, the patented Silvis Seal™ (#8707903) and Sani-Slope™ provides both superior floor mounting and leveling.

- Provides the ultimate solid watertight seal underneath division panels to ensure a one-of-a-kind layer of protection even if an isolation panel's silicone seal becomes cracked, hard or broken
- Prevents cross-contamination even when the primary bead of floor sealant has been breached or where there are cracks, waves, irregularities or other imperfections in the floor
- Is able to tolerate harsh cleaning agents such as chlorine bleach and ammonia, and withstands the force of pressure washing systems

Sani-Slope™ Advantages:

- Panels quickly and easily level to match the floor slope
- No need to cut panels to match the floor slope
- Less worry about floor dimensions
- Easily adapted to coved walls

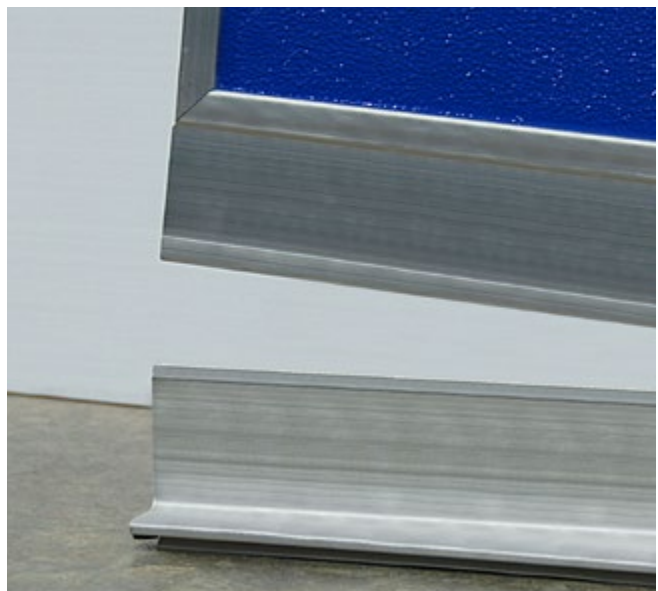
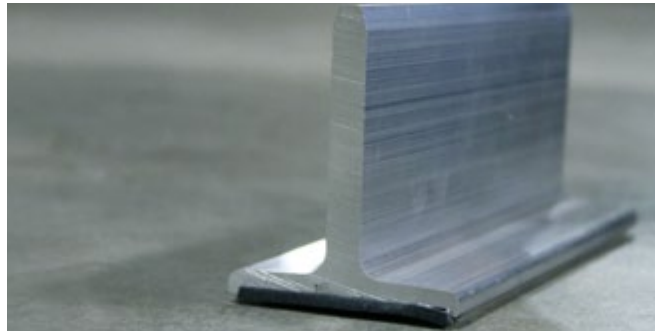
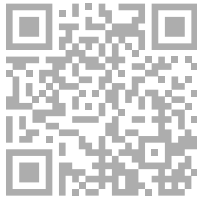

DOG SOLUTION

Stainless-Steel Kennels

A superior floor-mounting and leveling solution.

SilvisSeal is now available as part of the optional floating channels and features:

- 22 gauge 304 stainless steel
- 3/8" diameter stainless steel rods on doors and side panels
- 1" stainless steel square tubing
- 4' of isolation with stainless steel

Sani-Slope panels are easy to level to match the floor slope within your facility, without requiring custom trim panels. Panels adapt easily to coved walls.

STANDARD DOOR

- Reversible stainless steel doors – side by side units may be opened in opposite directions
- Stainless steel door hinges are mounted on the top and bottom, not the side

SLIDING DOOR

- One-hand operation
- Maximizes kennel room and eliminates the need for "swing door" space
- Maintenance-free marine grade anodized aluminum glide
- Available with stainless steel rods or glass panels

GLASS DOOR

- Full view for easy observation
- Easy, convenient cleaning
- Aesthetically pleasing
- Scratch resistant
- Available in sliding or hinged models



DOG SOLUTION

Stainless-Steel Kennel Systems

KENNEL 3'X6', 1 UNIT, GLASS DOOR

281-0010-00 Kennel 3'x6', 1 unit, Glass Door (no threshold), 2 side panels and 1 back panel \$4,728.00



KENNEL, 3'X6', 2 UNIT, GLASS DOOR

281-0010-01 Kennel, 3'x6', 2 unit, Glass Door (no threshold) 3 side panels and 2 back panels \$7,931.00



KENNEL 3'X6', 3 UNIT, GLASS DOOR

281-0010-02 Kennel 3'x6', 3 Unit, Glass Door (no threshold) 4 side panels and 3 back panels \$11,134.00

**KENNEL 3'X6', 4 UNIT, GLASS DOOR**

281-0010-03 Kennel 3'x6', 4 Unit, Glass Door (no threshold) 5 side panels and 4 back panels \$14,337.00

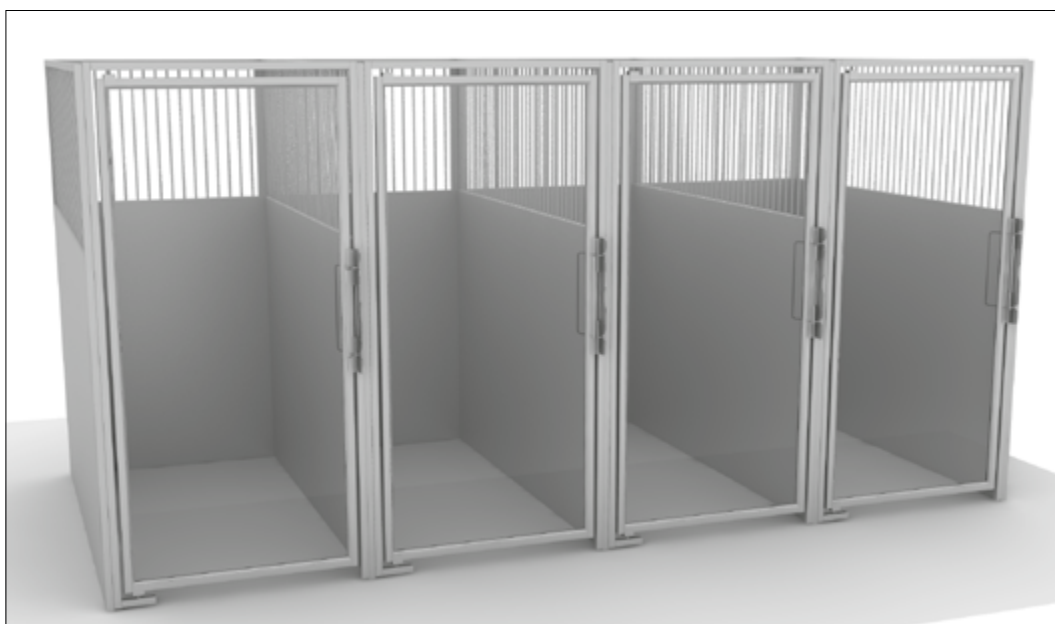

100% Stainless Steel Kennel Components

Kennel components are distinctively crafted from the most durable materials including 22-gauge, 304 stainless steel isolation panels with 3/8" stainless steel rods and 1" stainless steel square tubing.

RUN FRONT PANELS

- 181-0004-05 Run Rod Front Panel, 12"w (for use with 4' wide runs) \$282.00
- 181-0004-01 Run Glass Front Panel, 12"w (for use with 4' wide runs) \$282.00

RUN DOOR ASSEMBLIES

- 181-0001-01 Standard Run Door Assembly, 35"w (outside dimension) \$920.00
- 181-0001-02 Run Door Assembly with Bowl Bracket, 35"w (outside dimension) \$1,154.00
- 181-0001-25 Glass Run Door Assembly, 35"w (outside dimension) \$974.00
- 181-0001-06 Standard Run Door Assembly 35"w (no bottom frame) \$920.00
- 181-0001-26 Standard Glass Run Door assembly 35"w (no bottom frame) \$974.00

RUN DOOR ASSEMBLIES-SLIDING

Note: Sliding doors will open right to left unless otherwise specified.

- 181-0001-10 Sliding Run Door Assembly, 47.37"w (outer dimension) - Fits 4' Wide Runs, Provides 24" Opening \$1,928.00
- 181-0001-27 Sliding Glass Run Door Assembly, 47.37"w (outer dimension) Fits 4' Wide Runs, Provides 24" Opening \$2,087.00

RUN BACK PANELS

- 181-0003-00 Run Back Panel, Stainless Steel, 35"w \$704.00
- 181-0003-05 Run Back Panel, Stainless Steel, 47-3/8"w \$824.00

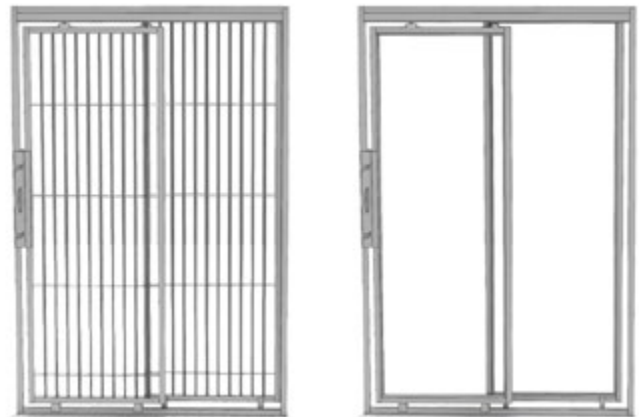
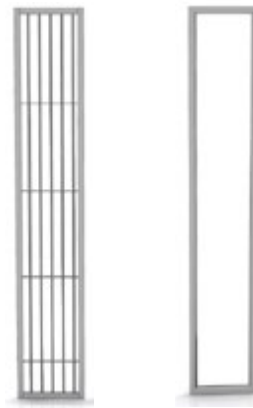

RUN SIDE PANELS – SIDE-BY-SIDE

181-0002-01	Run Side Panel, Stainless Steel, 72"	\$1,214.00
181-0002-51	Run Side Panel, Stainless Steel, 58"	\$1,085.00

FLOATING CHANNELS FOR SIDE PANELS

610-0427-12	Floating channel assembly, 6' (Qty 2)	\$310.00
610-0427-22	Floating channel assembly, 5' (Qty 2)	\$299.00
610-0427-32	Floating channel assembly, 4' (Qty 2)	\$279.00

RUN SIDE PANELS – BACK-TO-BACK

181-0002-11	Run Side Panel, Stainless Steel, 71"	\$1,214.00
181-0002-61	Run Side Panel, Stainless Steel, 57"	\$1,085.00

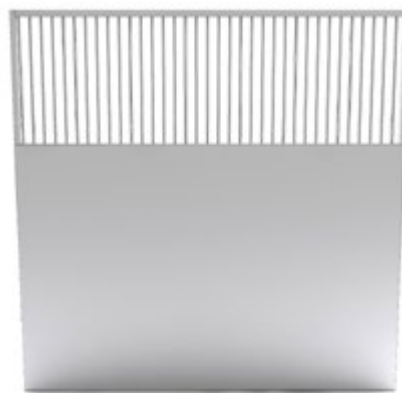

RUN FLOOR FRAMES

181-0005-00	Run Floor Frame, Stainless Steel, 36" w x 72" d	\$457.00
181-0005-01	Run Floor Frame, Stainless Steel, 48" w x 72" d	\$474.00
181-0005-20	Run Floor Frame, Stainless Steel, 36" w x 58" d	\$404.00
181-0005-11	Run Floor Frame, Stainless Steel, 48" w x 58" d	\$420.00



RUN DRAIN SYSTEMS

619-0440-00	Run Drain System, Stainless Steel, 36" x 72"	\$581.00
619-0440-01	Run Drain System, Stainless Steel, 48" x 72"	\$680.00
619-0440-03	Run Drain System, Stainless Steel, 36" x 58"	\$525.00
619-0440-04	Run Drain System, Stainless Steel, 48" x 58"	\$633.00



RUN FLOORING

72" Deep Run – PVC Coated Run Floor

616-0201-00	Run Floor, 35" w x 23" d (3 required per run)	\$515.00
616-0203-00	Run Floor, 47" w x 23" d (3 required per run)	\$436.00

58" Deep Run – Plastisol™ Coated Run Floor

616-0201-00	Run Floor, 35" w x 23" d (2 required per run)	\$515.00
616-0202-00	Run Floor, 36" w x 9" d (1 required per run)	\$371.00
616-0203-00	Run Floor, 47" w x 23" d (2 required per run)	\$436.00
616-0204-00	Run Floor, 47" w x 9" d (1 required per run)	\$335.00

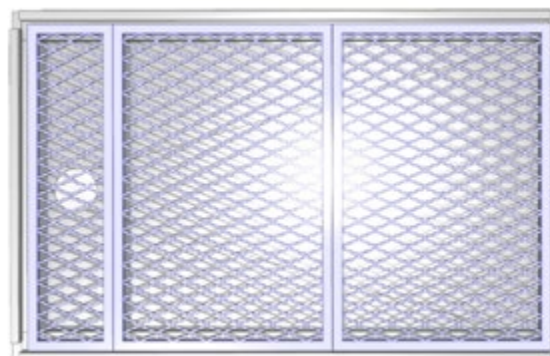

DOG SOLUTION

UltraBase™ Above Floor Kennels

No floor seam to bend, break or leak.

Midmark's UltraBase™ Above Floor Kennel System allows for the installation of indoor kennels in spaces not normally constructed for housing animals. The elevated floor stretches kennel space to install in locations that weren't previously possible.

The one-piece molded fiberglass base has a gentle side radius that extends up 6" so there is no floor-side seam to flex, crack and leak over time.

The base unit securely attaches to Midmark's isolation side panels for a watertight seal. Midmark's UltraBase™ features a slip-resistant floor base unit carefully engineered with an easy-to-clean special permanent texture and adjustable legs, allowing for installation on uneven floors.

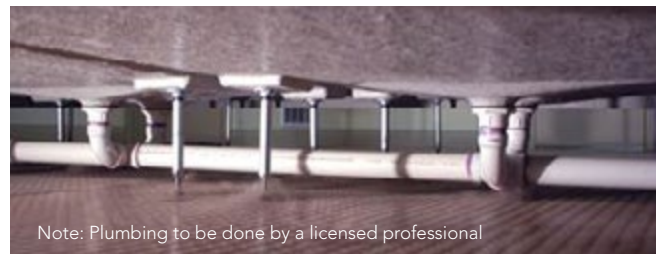

SU48-FDUWF00-875	4' Ultrabase FRP Side panel with wire - Blue	\$738.00
SU48-FDUWF00-255	4' Ultrabase FRP Side panel with wire - Sage	\$738.00
SU48-FDUWF00-245	4' Ultrabase FRP Side panel with wire - Sky	\$738.00
SU48-FDUWF00-671	4' Ultrabase FRP Side panel with wire - Pearl	\$738.00
SU48-FDUWF00-878	4' Ultrabase FRP Side panel with wire - Beige	\$738.00
SU60-FDUWF00-875	5' Ultrabase FRP Side panel with wire - Blue	\$865.00
SU60-FDUWF00-255	5' Ultrabase FRP Side panel with wire - Sage	\$865.00
SU60-FDUWF00-245	5' Ultrabase FRP Side panel with wire - Sky	\$865.00
SU60-FDUWF00-671	5' Ultrabase FRP Side panel with wire - Pearl	\$865.00
SU60-FDUWF00-878	5' Ultrabase FRP Side panel with wire - Beige	\$865.00
SU72-FDUWF00-875	6' Ultrabase FRP Side panel with wire - Blue	\$972.00
SU72-FDUWF00-255	6' Ultrabase FRP Side panel with wire - Sage	\$972.00
SU72-FDUWF00-245	6' Ultrabase FRP Side panel with wire - Sky	\$972.00
SU72-FDUWF00-671	6' Ultrabase FRP Side panel with wire - Pearl	\$972.00
SU72-FDUWF00-878	6' Ultrabase FRP Side panel with wire - Beige	\$972.00

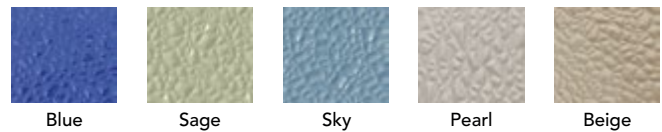

BU36-NFF0000-875	3' Ultrabase solid FRP Back panel - Blue	\$655.00
BU36-NFF0000-255	3' Ultrabase solid FRP back panel - Sage	\$655.00
BU36-NFF0000-245	3' Ultrabase solid FRP Back panel - Sky	\$655.00
BU36-NFF0000-671	3' Ultrabase solid FRP Back panel - Pearl	\$655.00
BU36-NFF0000-878	3' Ultrabase solid FRP Back panel - Beige	\$655.00
BU48-NFF0000-875	4' Ultrabase solid FRP Back panel - Blue	\$773.00
BU48-NFF0000-255	4' Ultrabase solid FRP Back panel - Sage	\$773.00
BU48-NFF0000-245	4' Ultrabase solid FRP Back panel - Sky	\$773.00
BU48-NFF0000-671	4' Ultrabase solid FRP Back panel - Pearl	\$773.00
BU48-NFF0000-878	4' Ultrabase solid FRP Back panel - Beige	\$773.00

DOG SOLUTION

Space Saver Folding Kennel

Maximize Your Space and Increase Your Bottom Line.

Midmark's innovative Space Saver Folding Kennels offer the ultimate flexibility. Whether you want to create an isolation area or an overflow option for boarding, these collapsible kennels are ideal for pet resorts or veterinary clinics that want to easily customize a space as needed.

The Space Saver kennels use the existing floor with Midmark's patented SilvisSeal to prevent cross-contamination and spreading disease through the flooring system.

Standard sizes are 3' x 3' or 4' x 4'.

The upper section can be designed with stainless steel wire, bone grid or a solid material (FRP, Wilsonart® or stainless steel over Polycore). The bottom section can be designed with FRP, Wilsonart® or stainless steel over Polycore.

Note: The system requires a flat solid wall and an additional kennel width of clearance on both sides.

Call for 1.800.543.5567 for a quote!

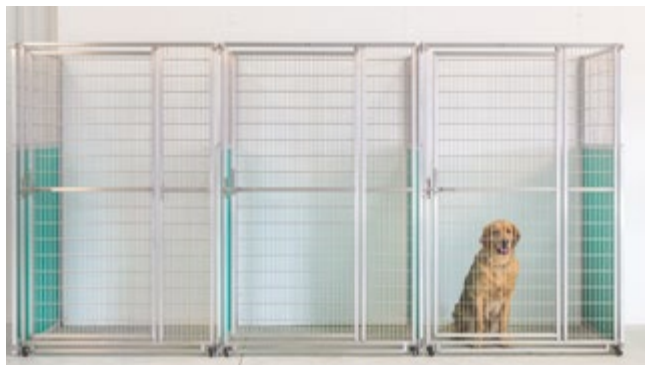

NOTE: For ordering information or to ask about part number items shown above, contact us at 1.800.543.5567.

[Back to Contents](#)

DOG SOLUTION

Accessories

Midmark offers a variety of accessory elements designed to enhance comfort, add utility and convenience, or improve aesthetics.

TRANSFER DOORS:

- Standard Wall-Mounted Doors
- Cable Guard Wall-Mounted Doors
- Fiberglass Insulated Doors
- Panel-Mounted Doors
- Pickwick Dog-Operated Doors
- Locking Transfer Doors



REST BENCHES

- All rest benches are available in freestanding and swing up styles

• **Frame:** Aluminum **Benches:** Stainless Steel, FRP

10010931-878	Rest Bench Aluminum Framed - Swing-up 3 ft Aurora Ultrabase-Beige	\$344.00
10010932-878	Rest Bench Aluminum Framed - Swing-up 4 ft Aurora Ultrabase-Beige	\$388.00
10010931-671	Rest Bench Aluminum Framed - Swing-up 3 ft Steel Grey Ultrabase- Pearl	\$344.00
10010932-671	Rest Bench Aluminum Framed - Swing-up 4 ft Steel Grey Ultrabase- Pearl	\$388.00
10010791	2'x3' Freestanding Dog Bench - White	\$344.00
10010792	2'x4' Freestanding Dog Bench - White	\$388.00

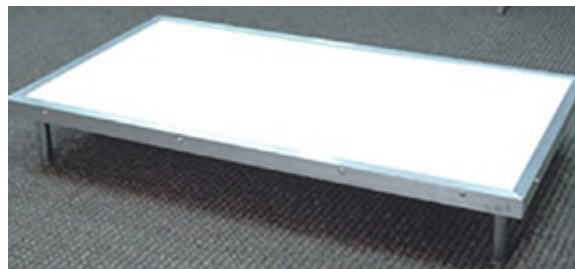

BOWL SYSTEMS:

- Built-in Single and Double Bowl Brackets
 - 2-3/4 Quart
 - 1 Quart
- Rotary Double Bowl Insert
 - 1 Quart

RAISED FLOORING:

- Plastisol Coated Steel-Core
 - Blue
 - Orange
 - Beige
- Fiberglass Composite

OTHER ACCESSORIES:

- Bone Shaped Weight Assist Handle
- Cardholders
- Decorative Gate Tops
 - Arched Tops
 - Dog Silhouettes
- Feeders
- Nelson Automatic Waterer
- Cleaning Products
 - Midmark Kennel Clean
 - Midmark Kennel Shine



GUTTER COVERS:

- Aluminum Gutter Cover

LATCHES:

- Patented Stainless Steel Two-Way Latch
- Magna Latch

TOP COVERS:

- Welded Wire Top Covers
- Chain Link Top Covers
- Poly-mesh Top Covers



CAT SOLUTION

Cat Condos-Raintree

Raintree™ Cat Condos are beautiful, durable, high-quality furniture pieces with amenities to pamper finicky felines.

Designed specifically for feline boarding needs, standard features include a built-in feeding/watering ledge, a resting shelf and a privacy area for litter. The Raintree™ Cat Condo is the ultimate in comfort and functional design.

Each condo consists of a top and bottom unit with coated wire mesh doors for healthy air circulation, or optional tempered glass doors and internal air ducts. Each module is 84" tall, 24" wide and 24" deep. Stainless steel hinges with a soft close feature help decrease stress and anxiety by eliminating slamming doors that can startle and scare cats.

10010733-337	Cat Condo, Quad-unit w/litter, Wire Doors, White	\$8,334.00
10010734-337	Cat Condo Quad-unit w/litter, Glass Doors, White	\$9,039.00
10010733-888	Cat Condo Quad-unit w/litter, Wire Doors, Mahogany Impressions	\$9,088.00
10010734-888	Cat Condo Quad-unit w/litter, Glass Doors, Mahogany Impressions	\$9,794.00
10010733-890	Cat Condo Quad-unit w/litter, Wire Doors, Napa Cherry	\$9,088.00
10010734-890	Cat Condo Quad-unit w/litter, Glass Doors, Napa Cherry	\$9,794.00
10010733-889	Cat Condo Quad-unit w/litter, Wire Doors, Swiss Pear	\$9,088.00
10010734-889	Cat Condo Quad-unit w/litter, Glass Doors, Swiss Pear	\$9,794.00
10010733-760	Cat Condo, Quad-unit w/litter, wire doors, Skyline Walnut	\$9,088.00
10010734-760	Cat Condo, Quad-unit w/litter, glass doors, Skyline Walnut	\$9,794.00

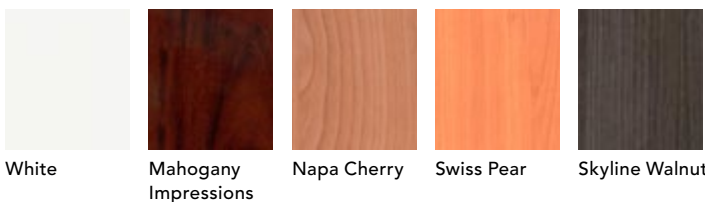

CAT SOLUTION

Cat Towers

Maximize space with customized high-rise living for cats.

Towers feature larger, multi-level areas of space that allow cats to explore, play or rest as they need. The vertical, high-rise footprint is ideal for maximizing space within your facility while economizing floor space.

Units are modular, customizable and available in a variety of non-organic materials that enable you to create an enriching and attractive environment for your feline friends.

Optional portals can be added, as well as designated feeding and litter areas. Cat Towers can also be configured using Raintree™ Cat Condos as the main living areas and Cat Towers as supplemental play spaces. The possibilities are unlimited when creating spaces for happier, more relaxed cat residents.

CUSTOMIZABLE OPTIONS

Panels: Stainless Steel, Wilsonart®, FRP Panels

Finishes: Stainless Steel, Tempered Glass,

Accessories: Shelves/Ledges, Portals, Bowl Systems

Call for 1.800.543.5567 for a quote!



CAT SOLUTION

Custom Cat Runs

Cats will enjoy multiple levels of climbing ladders and perching shelves for exercise, rest and play.

Custom Cat Runs deliver the greatest amount of design flexibility for your facility—units are custom manufactured to your specifications and built to any length, width or height.

Available with durable FRP, stainless steel or Wilsonart® side materials, Cat Runs feature Midmark's patented stainless steel two-way latch system and can be configured with a variety of gate styles, and with or without cat doors.

Enjoy the flexibility of creating an attractive cat space suitable for your facility and your feline friends.

CUSTOMIZABLE OPTIONS

Panels: Stainless Steel, Wilsonart, FRP Panels

Finishes: Stainless Steel, Tempered Glass, Stainless Steel Slide Gates

Accessories: Shelves/Ledges, Portals, Bowl Systems

Call for 1.800.543.5567 for a quote!



CAT SOLUTION

Luxury Cat Condos

Based on guidelines from the Association of Shelter Veterinarians, Luxury Cat Condos are ideal for animal shelters.

Luxury Cat Condos are attractive and quiet, contributing to less stress and anxiety for cats. Incorporating best-practice recommendations from the ASV, condos offer separate areas for sleep, exercise and litter, enabling cats to explore, retreat and rest as they'd like. All of which help reduce stress for cats, which has been shown to improve adoption rates for shelter animals.

Luxury Cat Condos feature perching shelves; easy-close portal doors that eliminate the jarring door-slam; and wire-grid fronts that increase airflow while making it easier to interact with the cats.

Units are available in 3' and 4' widths, and single or double-stack configurations. Each comes standard with swivel-type casters for easy movement. You can also choose from a variety of non-organic materials, and door, window and portal styles.

CUSTOMIZABLE OPTIONS

Size: Midmark offers corner units to maximize your facility's capacity

Finishes: Skyline Walnut, Mahogany Impressions, Napa Cherry, Swiss Pear

Accessories: Glass Fronts, Wire Fronts, Glass Backs, Vertical/Horizontal Portals, Keyed Latches, See other accessories (page 60)



GLASS FRONT OPTION

Midmark Luxury Cat Condos can be ordered with glass fronts for a much healthier and more secure way to house cats. The glass is offset 1/8" and hangs over the door, allowing air to circulate under and into the cat's living space and keeps debris and disease from traveling to other units. Other units have portals in the front in the glass, which means germs can spread if a cat sneezes and fingers can get into the unit.

Call for 1.800.543.5567 for a quote!

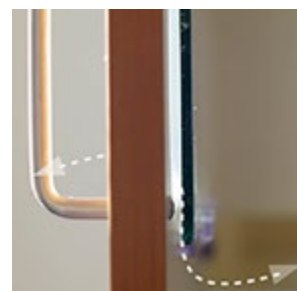

NOTE. For ordering information or to ask about part number items shown above, contact us at 1.800.543.5567.

[Back to Contents](#)

Cabinetry, Carts + Workstations

Meet the continually changing needs of your veterinary clinic with configurable cabinetry, mobile carts and workstations that help ensure supplies are available where and when you need them. By utilizing versatile equipment, you can maximize your space and optimize workflow, which all adds up to better patient care.



Synthesis[®] Cabinetry

The Blend of Beauty, Function and Design

Remodeling or building a new space can be overwhelming. That's where we come in. Synthesis[®] Cabinetry is designed to be easily configured to meet the needs of your unique space today and into the future. Let our in-house design team bring our inspired aesthetics, clinical designs and dependable Midmark quality together to help you create the clinical space of your dreams.

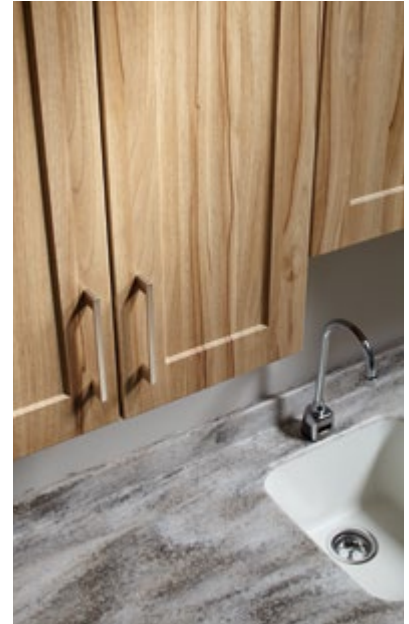

Initial Design Creation

Our in-house design team is skilled in creating efficient, effective veterinary workspaces.

Visit midmark.com/designcenter to start designing today!

Design Refinement

Our expert design team can create 3D virtual renderings of your dream space so you can see your options in living color.



Ordering and After-Sale Support

We'll see every detail through to ensure a positive experience from start to finish.

Contact Cabinetry Project Coordinators at **1.844.856.1236**.

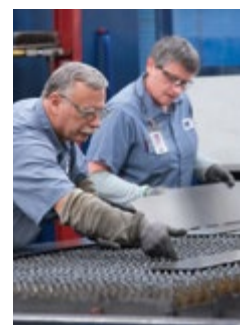

Synthesis® Cabinetry is designed to withstand the rigors of animal healthcare environments.

- Two lines of cabinetry available including traditional base and upper cabinets as well as wall-hung base and tall cabinets in numerous configurations to fit your animal care facility needs
- Gravity-fed, angled flow shelving to improve visibility and access to supplies
- Seamless polystyrene drawers with rounded corners and one-piece construction allow drawers to contain spills and clean easily
- Steel frame construction delivers long life and consistent door and drawer performance, while the flexible shell design allows configuration changes as needed
- Soft-close hinges and slides help maintain a quiet environment, supporting patient comfort
- Durable, adjustable 110-degree steel hinges give a distinct, clean look to the cabinetry
- Adjustable, self-cleaning ball bearing slides allow the drawers to slide in and out smoothly every time
- Optional surfaces and EPA-registered antimicrobial pulls and countertops help complement your current asepsis procedures
- Seamless thermofoil panels resist the spill damage, chemical degradation and delamination that often occur in common millwork products.

Contact Cabinetry Project Coordinators at **1.844.856.1236**.

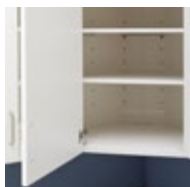
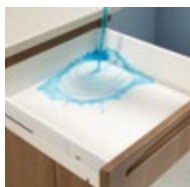

Synthesis® Wall-Hung Cabinetry

Midmark is building on a solid foundation of Synthesis Cabinetry and proud to offer a new line of wall-hung base and tall cabinets. Built with all the principles of Synthesis Cabinetry in mind, this new cabinetry further enhances how you store and access the supplies you need.

ENHANCED ERGONOMICS

Improved reach and visibility take the strain out of accessing necessary supplies.

GREATER VISIBILITY

Sufficient visibility into storage areas, standardization of supplies through organization and elimination of wasted storage space.

IMPROVED CLEANABILITY

Easier wall-to-wall cleanability and infection prevention in high traffic areas.



Standard Cabinet Configuration

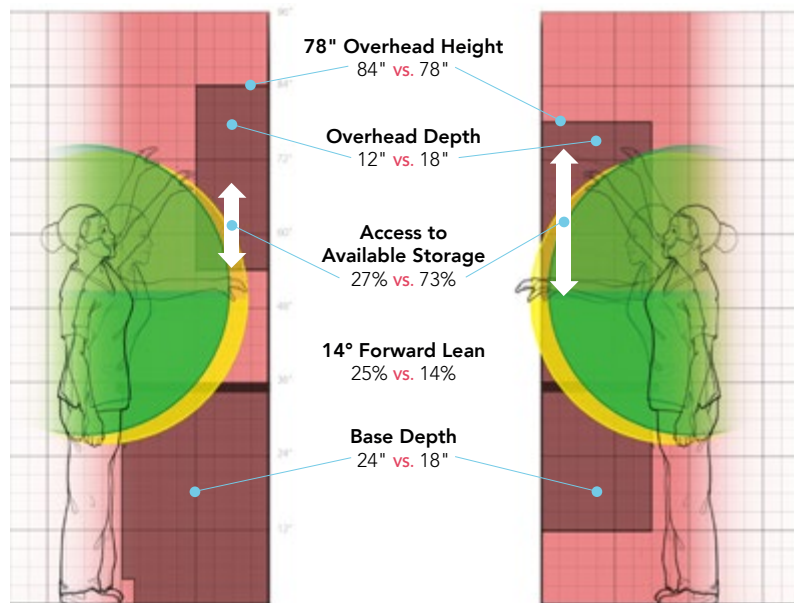

Based on 50th percentile female reach.

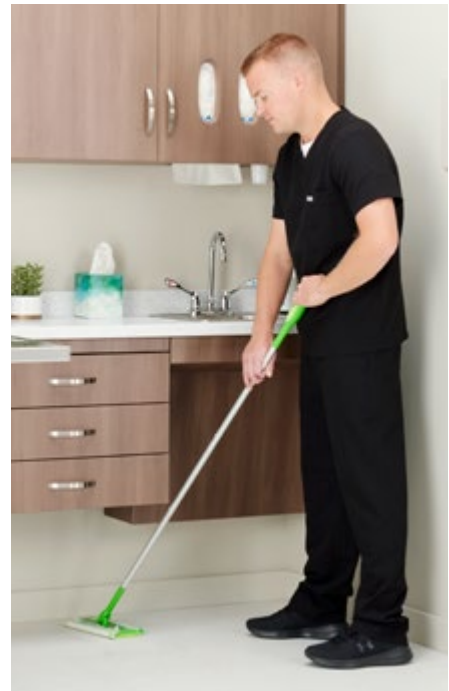

Supply Bins + Flow Shelves

Midmark Supply Bins and Flow Shelves fit seamlessly into Synthesis Cabinetry to ensure your supplies are easy to see and access.

Stackable Supply Bins keep your most-used items organized and within easy reach, streamlining efficiency during patient exams or procedures. Gravity-fed angled Flow Shelves provide better visibility and accessibility to supplies, even items stored at the back of the cabinet. Synthesis Cabinetry accommodates Flow Shelves and Supply Bins. Your current Synthesis cabinetry could be outfitted. Please contact your Midmark Territory Portfolio Manager to discuss. Custom-configured options are also available to meet your storage needs.



002-10708-00	Midmark Supply Bins 6" x 6" (8 Count)	\$130.00
002-10709-00	Midmark Supply Bins 3" x 12" (4 Count)	\$79.00
002-10710-00	Midmark Supply Bins 6" x 12" (4 Count)	\$100.00
002-10711-00	Midmark Supply Bins 12" x 12" (2 Count)	\$72.00
002-10712-00	Midmark Supply Bin Lids 6" x 6" (8 Count)	\$100.00
002-10713-00	Midmark Supply Bin Lids 3" x 12" (4 Count)	\$64.00
002-10714-00	Midmark Supply Bin Lids 6" x 12" (4 Count)	\$72.00
002-10715-00	Midmark Supply Bin Lids 12" x 12" (2 Count)	\$47.00
002-10716-00	Midmark Supply Bin Dividers 6" (4 Count)	\$36.00
002-10717-00	Midmark Supply Bin Dividers 12" (4 Count)	\$36.00



6" x 6"



3" x 12"



6" x 12"



12" x 12"



NOTE: For ordering information or to ask about part number items shown above, contact us at 1.844.856.1236.

[Back to Contents](#)

Veterinary Treatment Chase

Our space-saving chase designs allow you to have the equipment you need, where you need it, without sacrificing floor space. Maximize the open floor space in your treatment area with a treatment chase to help create the most efficient, effective space possible.

- The treatment chase units are pre-configured to arrive at your hospital ready for installation
- Wall mount light plates bolt securely to the chase unit so your procedure light can be positioned where you need it with no sag or drift
- Plumbing and electrical lines are neatly concealed within the chase
- A pentagonal configuration is also available that has convenient 4" access panels





PENTAGONAL CHASE CONFIGURATION

Ideal configuration for a more limited treatment space.
Features 4" access panels



Access Panel

Synthesis[®] Color + Style Options

Put your unique signature on your space, whether it is in one hospital or standardization across many animal care facilities.

HANDLE STYLES



PANEL STYLES



*EPA Registration Numbers 85353-2 and 087753-CT-001

**Cabinetry available in Pebble Grey or Pebble Grey PVC Free only. Renew handle insert color can be customized.

Cabinet Finishes

Thermofoil



Dune-794

Flax-795

Nest-796

Path-798

Brazilwood-847

Hewn-797

Radiance-800

Acorn-459

Henna-803

Sediment-799

Earth-487

Timber-801

Storm-802

Earthen Bronze (metallic)-806

Venus Silver (metallic)-804

Flat Iron (metallic)-807

Pearl Essence (metallic)-805

Fawn-490

Whisper-649

Pebble Grey-216 (PVC Free-793)

Frost-791

Countertops

Corian® Solid Surface

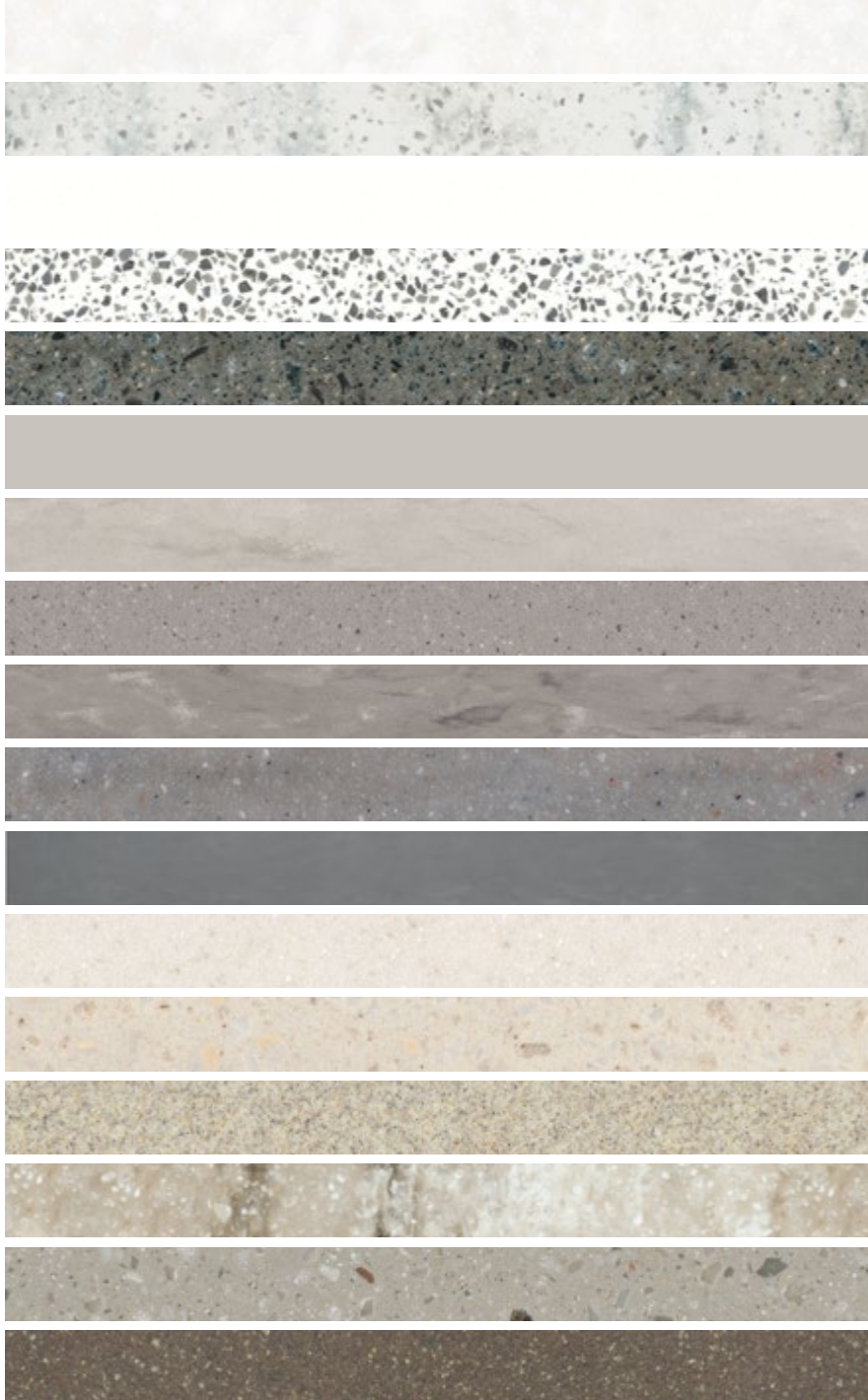

Sparkling White-902

Antarctica-461

Arrowroot-718

Silver Birch-638

Domino Terrazzo-900

Lava Rock-499

Pearl Gray-616

Neutral Aggregate-901

Dove-486

Ash Aggregate-898

Juniper-692

Weathered Concrete-903

Linen-324

Clam Shell-480

Sandstone-294

Hazelnut-719

Willow-410

Canyon-246

Countertops

Wilsonart® and Formica® Laminate



Frosty White—678

Paloma Polar—905

Drama Marble—908

Neo Cloud—907

Argento Romano—904

Elemental Concrete—906

Praline Antico—911

Ebony Fusion—456

Smoky Topaz—445

Oiled Soapstone—910

Polished Concrete—909

Kalahari Topaz—443

Concrete Stone—362

Natural Canvas—712

Brazilian Brown Granite—710

Milano Quartz—453

Butterum Granite—714

Jamocho Granite—715















Labrador Granite—708

The color swatches shown are the best representation of the original material. Actual colors may vary slightly. In order to confirm your color selection, we strongly recommend that you contact Midmark Customer Experience at 1.800.MIDMARK to request a sample before placing an order.

Laminate colors listed in the color options guide are Formica® or Wilsonart®, the solid surface countertops are Corian®. Wilsonart is a registered trademark of Premark RWP Holdings, Inc. Formica is a registered trademark of The Diller Corporation. Corian Solid Surface are registered trademarks of E. I. du Pont de Nemours and Company.

Renew Handle

Insert Colors

	Pebble Grey-216
	Arctic-244
	Shadow-232
	Fossil Grey-238
	Terra Cotta/Canyon-246
	Clay-234
	Tea Green/Olivine-237
	Silver Sage/Spruce-242
	Moss-230
	Cashmere Blue/Sky-239
	Dusty Blue-233
	Blueberry/Pacific Blue-235
	Navy-231
	Perfect Plum-229
	Black/Raven Wing-312

Synthesis® Mobile Carts

Mobile treatment carts have all of the same safe, efficient features as our cabinetry with the ability to move them where you need them.

MOBILE TREATMENT CART M2

- 27" W x 18" D x 33" H (2) 4" Drawers and (2) Doors
- Serenity panel style with flare handles
- Shipping Weight: 155 lb



Step 1: Configuration		List Price
M2		
Step 2: Depth		
1	18" Deep	\$1,917.00
Step 3: Option Package		
A	60 mm Casters	\$0
B	4" Quiet Casters	\$68.00
C	60 mm Casters and Keyed Locks	\$167.00
D	4" Quiet Casters and Keyed Locks	\$261.00
Step 4: Cabinetry Finish*		
XXX	Solid Color Cabinet Finish (Excludes PVC-Free)	\$0
XXX	Woodgrain, Metallic and PVC-free Cabinet Finish	\$225.00
Step 5: Countertop Type		
KCN	Kydex® Contour Top	\$0
SEB	Soft Edge Bumper Top	\$459.00
Configuration Example: M21A.791.KCN		\$1,917.00

Color-Specific Part Number Explanation:

M21A.791.KCN

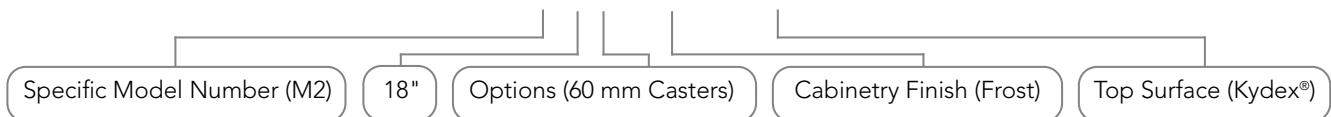

See color chart on pages 69-70 for available cabinetry finish options.

MOBILE TREATMENT CART M4

- 27" W x 18" D x 33" H (3) 4" Drawers & (1) 8" Drawer
- Serenity panel style with flare handles
- Shipping Weight: 152 lb



Step 1: Configuration		List Price
M4		
Step 2: Depth		
1	18" Deep	\$2,201.00
Step 3: Option Package		
A	60 mm Casters	\$0
B	4" Quiet Casters	\$68.00
C	60 mm Casters and Keyed Locks	\$171.00
D	4" Quiet Casters and Keyed Locks	\$240.00
Step 4: Cabinetry Finish*		
XXX	Solid Color Cabinet Finish (Excludes PVC-Free)	\$0
XXX	Woodgrain, Metallic and PVC-free Cabinet Finish	\$225.00
Step 5: Countertop Type		
KCN	Kydex® Contour Top	\$0
SEB	Soft Edge Bumper Top	\$459.00
SEH	Soft Edge Handle Top (29"W)	\$591.00
Configuration Example: M41A.791.SEB		\$2,660.00

MOBILE TREATMENT CART M5

- 27" W x 18" D x 33" H (5) 4" Drawers
- Serenity panel style with flare handles
- Shipping Weight: 159 lb



Step 1: Configuration		List Price
M5		
Step 2: Depth		
1	18" Deep	\$2,465.00
Step 3: Option Package		
A	60 mm Casters	\$0
B	4" Quiet Casters	\$68.00
C	60 mm Casters and Keyed Locks	\$171.00
D	4" Quiet Casters and Keyed Locks	\$240.00
Step 4: Cabinetry Finish*		
XXX	Solid Color Cabinet Finish (Excludes PVC-Free)	\$0
XXX	Woodgrain, Metallic and PVC-free Cabinet Finish	\$225.00
Step 5: Countertop Type		
KCN	Kydex® Contour Top	\$0
SEB	Soft Edge Bumper Top	\$459.00
SEH	Soft Edge Handle Top (29"W)	\$591.00
Configuration Example: M51A.791.SEB		\$2,924.00

See color chart on pages 69-70 for available cabinetry finish options.

Synthesis® Procedure Carts

Ensure resources are ready when and where you need them with Synthesis Procedure Carts. This 42-inch standing-height cart is designed to be a shared mobile resource that can be used across your veterinary clinic, providing 30% more storage than the average treatment cart.

- Agility to make any space a direct point of care
- Flexibility to be shared across multiple rooms, including dental, surgery suites and treatment areas
- Multiple configurations: P1, P2 and P3
- Resting elbow height of 43.5" for preferred workspace ergonomics
- 4" casters for superior stability and mobility
- Enhanced anti-tip drawer feature to prevent any accidental tipping
- Aesthetically pleasing design to match any Midmark Synthesis Cabinetry
- Slide-out worksurface perfect for any electronic device for X-ray reference or electronic charting

Accessories:

- Transit Handle
- Side Accessory Rails
- Above-Surface Rails
- Sani-Wipes Holder
- Single- or Three-Box Glove Holders
- Waste Holder
- Sharps Container
- 6" x 6" Storage Bin



Cabinetry, Carts + Workstations

Color-Specific Part Number Explanation: P21N.XXX.KCT

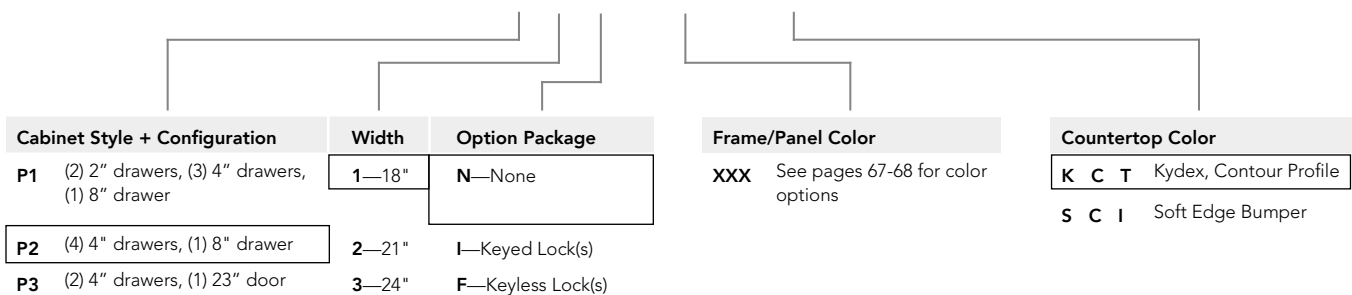

NOTE: For ordering information or to ask about part number items shown above, contact us at 1.844.856.1236.

[Back to Contents](#)

P1 PROCEDURE CART

- Cascade panel style with arc handles
- 43" H x 18" D and available in 18", 21" and 24" W
- Cascade panel style with arc handles
- Drawer configuration:
 - 2—2" drawers
 - 3—4" drawers
 - 1—8" drawer



Shown in 24" width

Above Procedure Cart shown in Storm (802).

See color chart on pages 69-70 for available cabinetry finish options.

List Price

Step 1: Configuration

P1	(2) 2" drawers, (3) 4" drawers, (1) 8" drawer Slide-out Worksurface, 4" Casters, Base Bumper	
----	-------------------------------------------------------------------------------------------------	--

Step 2. Width

1	18" wide	\$2,866.00
2	21" wide	\$2,961.00
3	24" wide	\$3,096.00

Step 3. Options

N	None	\$0
E	Keyed Lock	\$197.00
F	Keyless Lock	\$486.00

Step 4. Cabinetry Finish*

XXX	Solid Color Cabinet Finish (Excludes PVC-Free)	\$0
XXX	Woodgrain, Metallic and PVC-free Cabinet Finish	\$281.00

Step 5. Countertop Type

KCT	Kydex® Contour Top	\$0
SCT	Soft-Edge Contour Top	\$220.00

Step 6. Accessories

LHHE, RHHE, LHUA, LHDA, RHUA, RHDA and RPCK are PLANT INSTALLED ONLY.

Plant Installed:

LHHE	—	Side Transport Handle, LH mount	\$256.00
RHHE	—	Side Transport Handle, RH mount	\$256.00
LHUA	—	Side Accessory Rail, LH mount- upper only	\$40.00
LHDA	—	Side Accessory Rail, LH mount-dual	\$80.00
RHUA	—	Side Accessory Rail, RH mount- upper only	\$40.00
RHDA	—	Side Accessory Rail, RH mount-dual	\$80.00
RBCK	—	Top Accessory Rack	\$282.00

These accessories below require one or more of LHUA, LHDA, RHUA, RHDA or RBCK to hold them.

Field Installed:

SBL	9A688001	Storage Bins/Hinged Lid	\$37.00
MWC	9A689001	Waste Can w/Hanging Bracket	\$124.00
SWH	9A690001	Sani-Wipe Holder	\$48.00
MSC	9A691001	Sharps Cabinet w/Hanging Bracket	\$137.00
SGH	9A692001	Single Glove Box Holder	\$70.00
TGH	9A693001	Three Glove Box Holder	\$88.00

P2 PROCEDURE CART

- Cascade panel style with arc handles
- 43" H x 18" D and available in 18", 21" and 24" W
- Cascade panel style with arc handles
- Drawer configuration:
 - 4—4" drawers
 - 1—8" drawer



Shown in 24" width

Above Procedure Cart shown in Frost (791).

See color chart on pages 69-70 for available cabinetry finish options.

List Price

Step 1: Configuration		
P2	(4) 4" drawers, (1) 8" drawer Slide-out Worksurface, 4" Casters, Base Bumper	
Step 2: Width		
1	18" wide	\$2,686.00
2	21" wide	\$2,802.00
3	24" wide	\$2,920.00
Step 3: Options		
N	None	\$0
E	Keyed Lock	\$197.00
F	Keyless Lock	\$486.00
Step 4: Cabinetry Finish*		
XXX	Solid Color Cabinet Finish (Excludes PVC-Free)	\$0
XXX	Woodgrain, Metallic and PVC-free Cabinet Finish	\$281.00
Step 5: Countertop Type		
KCT	Kydex® Contour Top	\$0
SCT	Soft-Edge Contour Top	\$220.00
Step 6: Accessories		
FLHHE, RHHE, LHUA, LHDA, RHUA, RHDA and RPCK are PLANT INSTALLED ONLY.		
Plant Installed:		
LHHE	— Side Transport Handle, LH mount	\$256.00
RHHE	— Side Transport Handle, RH mount	\$256.00
LHUA	— Side Accessory Rail, LH mount- upper only	\$40.00
LHDA	— Side Accessory Rail, LH mount-dual	\$80.00
RHUA	— Side Accessory Rail, RH mount- upper only	\$40.00
RHDA	— Side Accessory Rail, RH mount-dual	\$80.00
RBCK	— Top Accessory Rack	\$282.00
These accessories below require one or more of LHUA, LHDA, RHUA, RHDA or RBCK to hold them.		
Field Installed:		
SBL	9A688001 Storage Bins/Hinged Lid	\$37.00
MWC	9A689001 Waste Can w/Hanging Bracket	\$124.00
SWH	9A690001 Sani-Wipe Holder	\$48.00
MSC	9A691001 Sharps Cabinet w/Hanging Bracket	\$137.00
SGH	9A692001 Single Glove Box Holder	\$70.00
TGH	9A693001 Three Glove Box Holder	\$88.00

P3 PROCEDURE CART

- Cascade panel style with arc handles
- 43" H x 18" D and available in 18", 21" and 24" W
- Cascade panel style with arc handles
- Drawer configuration:
 - 2—4" drawers
 - 1—23" door with adjustable shelf



Shown in 21" width

Above Procedure Cart shown in Storm (802).

See color chart on pages 69-70 for available cabinetry finish options.

List Price

Step 1: Configuration

P3	(2) 4" drawers, (1) 23" door w/1 adjustable shelf Slide-out Worksurface, 4" Casters, Base Bumper	
----	-----------------------------------------------------------------------------------------------------	--

Step 2: Width

1	18" wide	\$2,102.00
2	21" wide	\$2,144.00
3	24" wide	\$2,255.00

Step 3: Options

N	None	\$0
E	Keyed Lock	\$197.00
F	Keyless Lock	\$486.00

Step 4: Cabinetry Finish*

XXX	Solid Color Cabinet Finish (Excludes PVC-Free)	\$0
XXX	Woodgrain, Metallic and PVC-free Cabinet Finish	\$281.00

Step 5: Countertop Type

KCT	Kydex® Contour Top	\$0
SCT	Soft-Edge Contour Top	\$220.00

Step 6: Accessories

LHHE, RHHE, LHUA, LHDA, RHUA, RHDA and RBCK are PLANT INSTALLED ONLY.

Plant Installed:

LHHE	—	Side Transport Handle, LH mount	\$256.00
RHHE	—	Side Transport Handle, RH mount	\$256.00
LHUA	—	Side Accessory Rail, LH mount- upper only	\$40.00
LHDA	—	Side Accessory Rail, LH mount-dual	\$80.00
RHUA	—	Side Accessory Rail, RH mount- upper only	\$40.00
RHDA	—	Side Accessory Rail, RH mount-dual	\$80.00
RBCK	—	Top Accessory Rack	\$282.00

These accessories below require one or more of LHUA, LHDA, RHUA, RHDA or RBCK to hold them.

Field Installed:

SBL	9A688001	Storage Bins/Hinged Lid	\$37.00
MWC	9A689001	Waste Can w/Hanging Bracket	\$124.00
SWH	9A690001	Sani-Wipe Holder	\$48.00
MSC	9A691001	Sharps Cabinet w/Hanging Bracket	\$137.00
SGH	9A692001	Single Glove Box Holder	\$70.00
TGH	9A693001	Three Glove Box Holder	\$88.00

Mobile Workstations

Choose from numerous configurations that help you utilize your hardware while keeping your focus and eye contact on your patients and clients.

- 26 inches of adjustment allows for a wide range of ergonomically correct positioning whether seated or standing
- 4-inch caster base enables easy maneuverability
- 180 degrees of rotation helps maintain eye contact with your patients

6212 FLAT PANEL PC WORKSTATION

- Flat panel arm with 100 mm to 75 mm standard mounting locations
- Height adjustment from 23" to 49" from the floor
- 26" W x 23" D worksurface
- Weight capacity: 30 lbs

6212-001-XXX 6212 Flat Panel PC Workstation \$1,942.00

6212 ACCESSORIES

Plant Install	Field Install		
AIOM	n/a	All-In-One Monitor (Weight Reference)	
BCHD	9A664001	Bar Code Holder VESA Mount	\$82.00
BCHL	9A659001	Bar Code Holder-LH	\$51.00
BCHR	9A659001	Bar Code Holder-RH	\$51.00
BPCH	9A658001	Blood Pressure Cuff Holder	\$105.00
CPUB	9A663001	CPU Holder-Back	\$334.00
CPUF	9A663001	CPU Holder-Front	\$334.00
CCWT	9A657001	Counterweights	\$156.00
DBCM	9A653001	Double Column Basket	\$144.00
DWLW	9A647001	Drawer w/Lock-Work Surf Mnt	\$490.00
DWNW	9A646001	Drawer-Work Surf Mnt	\$201.00
EPWS	9A651001	Equipment Pole	\$173.00
LPDH	9A662001	Laptop Display Holder	\$131.00
MPSF	9A648001	Mobile Printer Shelf	\$159.00
PMSL	9A655001	AC Power System w/Steel Cable Mgmt-LH	\$4,642.00
PMSR	9A655001	AC Power System w/Steel Cable Mgmt-RH	\$4,642.00
RBWS	9A650001	Rear Basket	\$98.00
SBCB	9A652001	Single Basket-Back	\$91.00
SBCF	9A652001	Single Basket-Front	\$91.00
SCML	9A668001	Coiled Power Cord with Steel Brkt-LH	\$135.00
SCMR	9A668001	Coiled Power Cord with Steel Brkt-RH	\$135.00
SHLH	9A654001	Scale Holder-LH	\$163.00
SHRH	9A654001	Scale Holder-RH	\$163.00
TBDH	9A661001	Tablet Display Holder	\$131.00
USCB	9A656001	Utility Shelf	\$255.00
VESA	9A660001	VESA Mount Plate	\$119.00
VIPL	9A649001	VOIP Work Surface-LH Mount	\$148.00
VIPR	9A649002	VOIP Work Surface-RH Mount	\$148.00



6212-001-802

See color chart on page 70 for available cabinetry finish options.

6215 COMPACT WORKSTATION

Ideal workstation for smaller, more compact clinics and for users who prefer using a laptop or tablet to chart or monitor patients.

- Three compact, simple designs
- Ample work surface for a mouse and laptop
- Rectangular— 21" D x 26" W
- Compact Rectangular— 17.5" D x 23.5" W
- Compact Kidney— 17" D x 25" W
- Weight limit: 10 lbs.

6215-001-XXX	6215 Rectangular Workstation	\$1,398.00
6215-002-XXX	6215 Compact Rectangular Workstation	\$1,398.00
6215-003-XXX	6215 Compact Kidney Workstation	\$1,398.00



6215-001-802
6215 Rectangular Workstation

6215 ACCESSORIES

Plant Install	Field Install		
AIOM	n/a	All-In-One Monitor (Weight Reference)	-
BCHL	9A659001	Bar Code Holder-LH**	\$51.00
BCHR	9A659001	Bar Code Holder-RH**	\$51.00
BPCH	9A658001	Blood Pressure Cuff Holder*	\$105.00
CPUB	9A663001	CPU Holder-Back**	\$334.00
CPUF	9A663001	CPU Holder-Front**	\$334.00
CCWT	9A657001	Counterweights**	\$156.00
DBCMB	9A653001	Double Column Basket**	\$144.00
DWLW	9A647001	Drawer w/Lock-Work Surf Mnt	\$490.00
DWNW	9A646001	Drawer-Work Surf Mnt	\$201.00
EPWS	9A651001	Equipment Pole*	\$173.00
MPSF	9A648001	Mobile Printer Shelf*	\$159.00
PMSL	9A655001	AC Power System w/Steel Cable Mgmt-LH*	\$4,642.00
PMSR	9A655001	AC Power System w/Steel Cable Mgmt-RH*	\$4,642.00
RBWS	9A650001	Rear Basket*	\$98.00
SBCB	9A652001	Single Basket-Back**	\$91.00
SBCF	9A652001	Single Basket-Front**	\$91.00
SCML	9A668001	Coiled Power Cord with Steel Brkt-LH**	\$135.00
SCMR	9A668001	Coiled Power Cord with Steel Brkt-RH**	\$135.00
SHLH	9A654001	Scale Holder-LH**	\$163.00
SHRH	9A654001	Scale Holder-RH**	\$163.00
USCB	9A656001	Utility Shelf**	\$255.00
VIPL	9A649001	VOIP Work Surface-LH Mount*	\$148.00
VIPR	9A649002	VOIP Work Surface-RH Mount*	\$148.00



6215-002-459
6215 Compact Rectangular Workstation



6215-003-459
6215 Compact Kidney Workstation

Wall-Mounted Workstation

6282 WORKSTATION

This stationary, adjustable-height work surface helps free floor space in your care area. Easy maneuverability allows care teams to more easily focus on their patients and clients.

- Compact folding design
- Integrated cable management
- Large, single plane worksurface to accommodate a full-sized keyboard and mouse
- 22" height adjustment
- 25" W x 10" D x 2.1" H workstation tray
- Weight capacity: 5-20 lbs

6282-001 6282 Workstation \$1,630.00

6282 ACCESSORIES

9A593001	Dual Monitor Arm	\$127.00
9A588001	20" Extension Arm	\$293.00
9A592001	VESA Mount Bar Code Holder	\$82.00
9A591001	Track Mount Barcode Holder	\$162.00
9A590001	Tamper Proof CPU Holder	\$425.00
9A589001	Adjustable CPU Holder	\$227.00



Dentistry Solutions

Offering comprehensive dentistry services promotes overall patient health—and it's good for business. The Midmark portfolio of dental products, clinical training, benchmarking resources, and design and workflow services helps you deliver an exceptional care experience.



Dental Delivery Systems

Midmark 1000

The Midmark 1000 is an all-in-one dental delivery system that does not require added equipment. Reliable and easy to use, it is an ideal choice when adding comprehensive dentistry to your practice.

- Fully enclosed delivery system makes cleaning quick and easy and minimizes compressor sound level
- All dental delivery systems include high- and low-speed handpieces, Midmark bur starter kit and starter supply of prophyl angles
- Integrated Acteon Satelec® Piezo Scaler saves valuable space and improves efficiency during the procedure. Scaler tips included
- Quickly toggle between the dual, 1-liter water bottles with a flick of a switch, without de-pressurizing the system
- Handpieces automatically activate when removed from holders allowing you to focus on your patient
- Medical-grade casters allow you to position the cart where you need it
- Optional LED and fiber optics for proper lighting
- Integrated oil-free compressor eliminates potential oil exposure to patients and messy changes
- Standard Midwest 4-hole connection
- 115V AC
- 10' hospital-grade powercord
- 18.5"w x 23"d x 36.5"h



8000-003	Midmark 1000 with non-lighted integrated scaler and fiber optics	\$9,668.00
8000-007S	Midmark 1000 with lighted integrated scaler and 2-position swivel high-speed handpieces	\$12,007.00
8000-008	Midmark 1000 with lighted integrated scaler	\$10,528.00
8000-008S	Midmark 1000 with lighted integrated scaler and swivel high-speed handpiece	\$10,996.00

9A560001	Midmark Dental Suction Accessory (In-clinic installation required)	\$481.00
002-1814-00	Suction Tips, HVE, 25/kit	\$13.00
002-1815-00	Suction Tips, Dental Aspirator, 25/kit	\$13.00

Midmark High-Speed Handpieces

- Smooth, quiet operation at 360,000–400,000 rpms
- Swivel high- and low-speed option—and light weight for improved ergonomics
- Ergonomic, wide, no-slip grip
- Debris-shield™ bearing shield system minimizes entry of debris into bearing
- 4 port spray for better water coverage and cooling
- Ceramic bearings for lower maintenance, extended life, and quiet operation
- Fast cutting power
- Manufactured in the USA
- 1-Year limited warranty (90 days on chuck)

002-10546-00	Midmark Standard Head High-Speed Non-Fiber Optic Dental Handpiece	\$560.00
002-10547-00	Midmark Standard Head High-Speed Fiber Optic Dental Swivel Handpiece w/ Coupler	\$1,115.00
002-10549-00	Midmark Standard Head High-Speed Fiber Optic Dental Handpiece	\$646.00
002-1432-00	Midmark Handpiece Cleaner/Conditioner	\$40.00
002-1432-01	Midmark Handpiece Cleaner/Conditioner Kit (Case of 12)	\$360.00



Midmark Fiber Optic High-Speed Handpiece, 002-10549-00



Midmark Fiber Optic Swivel High-Speed Handpiece and Coupler, 002-10547-00

Midmark Low-Speed Handpieces

- Ceramic bearings for lower maintenance, extended life and quiet operation
- Integrated swivel reduces hand fatigue
- Small and lightweight
- Smooth, quiet operation at 0-5,000 RPM
- Prophy heads slip in and out with easy locking mechanism
- Accepts all 3/32" burs and doriot heads
- Manufactured in the USA
- 1-year warranty

002-10748-00	Midmark Swivel Low-Speed Prophy Handpiece	\$948.00	002-1432-00	Midmark Handpiece Cleaner/Conditioner	\$40.00
002-1277-01	Midmark Low-Speed Handpiece Motor 0-20,000 RPM (Additional nose cone required: 016-1605-00)	\$435.00	002-1432-01	Midmark Handpiece Cleaner/Conditioner Kit (Case of 12)	\$360.00
016-1605-00	Nose Cone, 1:1, for exotics and advanced procedures (Use with 002-1277-01)	\$206.00			



Midmark Swivel Low-Speed Handpiece 002-10748-00

Dental Delivery Accessories

DENTAL BURS

Meisinger™ tungsten carbide instruments provide excellent quality

- Functional precision tooling
- Above-average concentricity
- Made of high-density fine-grain metal
- Round burs are typically used for burring away bone
- Inverted cone is for undercutting and restoration
- Cross Cut burs are for sectioning teeth
- Diamond burs are for smoothing bone and enamel

016-1204-00	#2 Round, 5/pk.	\$12.00
016-1204-01	#4 Round, 5/pk.	\$12.00
016-1204-02	#6 Round, 5/pk.	\$12.00
016-1204-05	#36 Inverted Cone, 5/pk.	\$12.00
016-1204-06	#558 Cross Cut Straight Fissure, 5/pk.	\$12.00
016-1204-07	#558L Cross Cut Straight Fissure, 5/pk.	\$12.00
016-1204-03	#701 Cross Cut Tapered Fissure, 5/pk.	\$12.00
016-1204-04	#701L Cross Cut Tapered Fissure, 5/pk.	\$12.00
016-1204-09	#831F Diamond Football, Fine, 5/pk.	\$60.00
016-1204-08	#869LF Diamond Torpedo, Fine, 5/pk.	\$60.00

NOTE: Explore all of the burs Midmark offers, visit midmarkserviceparts.com.

MIDMARK BUR STARTER KIT

Contains one of each standard bur and labeled, autoclavable holder.

002-1158-00	Midmark Bur Starter Kit	\$61.00
-------------	-------------------------	---------

RODENT DENTAL BUR KIT

002-1664-00	Rodent Dental Bur Kit for use with Midmark low-speed handpiece (002-1277-01) and 1:1 nose cone (016-1605-00)	\$187.00
016-1204-10	Diamond disc, medium grit, #930D	\$37.00
016-1204-37	Diamond Bur, extra long 5/pk.	\$60.00
057-1353-00	Dental Guard, Disc	\$61.00
057-1354-00	Dental Guard, Bur	\$61.00

CROSSTEX TWIST™ PROPHY ANGLES

The Crosstex twist™ is a unique, disposable prophy angle that moves in a 90° reciprocating, back-and-forth motion instead of a traditional spinning motion, which reduces hair and whiskers getting caught. This patented design eliminates the spatter of prophy paste, saliva, blood and other potentially infectious matter. It also eliminates frictional heat while maintaining continuous contact and pressure on the tooth surface.

002-1279-02	Crosstex TWIST prophy angles, 100/pk	\$218.00
-------------	--------------------------------------	----------



002-1158-00



002-1664-00



SATELEC® PIEZO HANDPIECES

- Linear vibration mimicks hand scaling
- Produces less heat to prevent enamel damage
- Thicker handpiece to help with hand fatigue
- Requires less water to cool tips
- LED option provides excellent lighting in hard to see areas
- Cruise control feature regulates scaling pressure to ensure patient safety



016-1218-00	Scaler Hand Piece	\$1,152.00
016-1375-00	LED Scaler Hand Piece	\$1,295.00

ACTEON SATELEC® SCALING TIPS*

Made from the best alloys, exclusive to Satelec®, using patented procedures.

- Corrosion resistant
- Autoclavable
- Calibration: each tip is individually tested and "tuned" using the latest in ultrasonic calibration techniques
- Spray Control System (SCS): more powerful cavitation, better spray control and perfectly-controlled vibration energy at the end of the instrument
- Color Coding System (CCS tips): inserts are color coded to show their recommended power range

016-1203-00	Universal, Tip No. 1	\$149.00
016-1203-03	Voluminous Calculus, Tip No. 2	\$149.00
016-1203-04	Shallow Pockets, Tip No. 10P	\$149.00
016-1203-01	Subgingival, Tip No. 10Z	\$179.00
016-1203-02	Periodontics, Micro Universal Curette, Tip No. H3	\$184.00
016-1203-13	Universal Scaling, Longer and Thinner, Tip No. 1S	\$175.00

*For a complete listing of tips available for the Acteon Satelec® Scaler visit midmarkserviceparts.com.

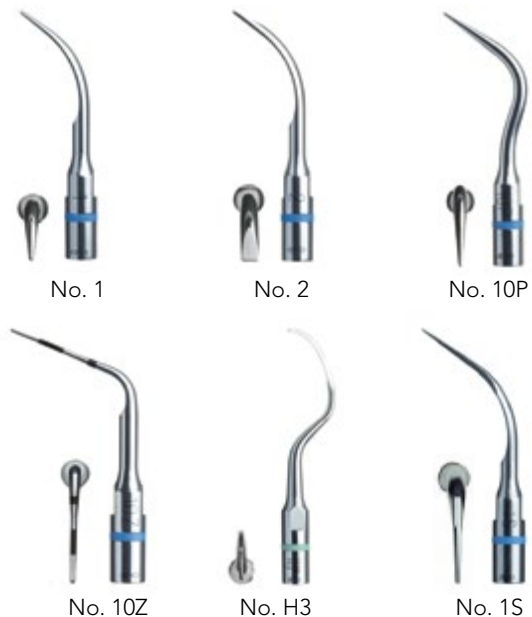

ACTEON UROLITHIASIS PROBES

Use ultrasonics to quickly and efficiently break up stones located in the urethra. Urolithiasis probes are compatible with the Satelec® ultrasonic scalers used in the Midmark dental delivery systems and are connected to the scaler handpiece in the same way as scaling tips.

016-1203-05	Dog probe, short (102 mm) (A)	\$144.00
016-1203-07	Dog probe, long (156 mm) (B)	\$144.00
016-1203-06	Cat probe (C)	\$144.00
002-1238-00	Kit, 3 Veterinary Urolithiasis Probes - Dog, short/Dog, long/Cat	\$370.00

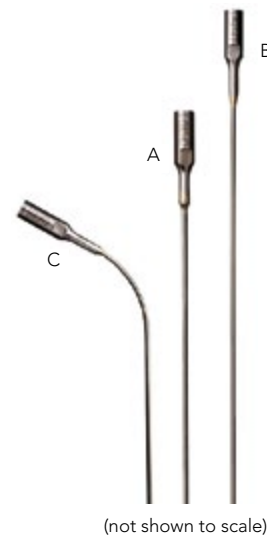

(not shown to scale)

Midmark Digital Dental Radiography Systems

Midmark Complete Digital Dental Radiography Systems

Combine the Midmark DC Generator with the Midmark Bite-Resistant DR Sensor for an unmatched synergy of technology and efficiency.

- The sensor plugs directly into the X-ray unit arm protecting your investment
- Provides a 0.4-mm focal spot for sharp, well-defined details that allow easy identification of pathology with digital sensors.

MIDMARK COMPLETE IMAGING SYSTEMS

DCVM-G0X/H/S4/L	Mobile, Handswitch, Size #2 Sensor, Laptop, Tray	\$21,876.00
DCVM-G0X/H/S4	Mobile, Handswitch, Size #2 Sensor	\$20,762.00
DCV5-G2X/H/S4	Midmark Complete, 56" 2 Stud, Handswitch, #2 Digital Sensor	\$20,266.00
DCV6-G2X/H/S4	Midmark Complete, 66" 2 Stud, Handswitch, #2 Digital Sensor	\$20,266.00
DCV7-G2X/H/S4	Midmark Complete, 76" 2 Stud, Handswitch, #2 Digital Sensor	\$20,266.00
DCV8-G2X/H/S4	Midmark Complete, 82" 2 Stud, Handswitch, #2 Digital Sensor	\$20,266.00

IMAGING ACCESSORIES

30-08180	Laptop	\$1,931.00
ASAM-GT	Laptop Tray for Mobile X-ray	\$515.00
ASAW-GT	Laptop Tray, Wall/Chase Mounted	\$2,184.00
WARRX1	X-ray Generator Factory Warranty Extension - 1 Year	\$501.00
WARRX2	X-ray Generator Factory Warranty Extension - 2 Years	\$905.00



Midmark® Bite-Resistant DR Sensor

Designed specifically for the unique needs of the animal health market.

The Midmark Bite-Resistant Sensor combines a unique geometric sensor housing design and exceptional image quality to provide clear, crisp radiographs with exceptional resistance to bite damage—FOUR TIMES stronger than our standard sensor.

The Midmark digital sensor is designed to deliver the soft-tissue visualization plus crown and root definition that you need to ensure you are providing your patients with superior dental care.

- Provides patent-pending geometric design for improved bite-resistance.
- Offers remarkable image resolution with more pixels per area (pixel size of 14 µm).
- Delivers exceptional high-quality images, even at low-dose radiation.
- Imparts a protective plate between the housing and imaging components, further enhancing durability.
- Uses Kevlar® reinforced cable for reliability and a water-tight connection to promote asepsis.
- Embedded with calibration files to simplify integration and workflow.
- Includes imaging software plus clinical and technical support.

MIDMARK DIGITAL SENSORS

XSVS-08	Size #2, 3 M Cable	\$13,425.00
XSVS-08/L	Size #2, 3 M Cable w/Laptop	\$14,871.00
XSVN-08	Size #2, 1.1 M Cable	\$13,425.00
002-10545-00	Sanitary Sheaths, 100/pk Bite-Resistant Sensor Size 2	\$73.00

WARRANTY:

A five year limited warranty is also included with the sensor purchase. If there is a catastrophic event making the sensor not function, it will be replaced at NO CHARGE the first time.

MOUTH PROPS

8597	MantaProp, mouth prop, small, box of 10	\$66.00
8598	MantaProp, mouth prop, medium, box of 10	\$66.00



Dentistry



NOTE: For ordering information or to ask about part number items shown above, contact us at 1.844.856.1236.

[Back to Contents](#)

Midmark DC Generator

Delivering the most stable arm in the industry, the Midmark DC Generator leads the market with its proprietary braking mechanism in the horizontal and articulating arm. The Midmark DC is a high-frequency, veterinary-specific dental radiography system designed to meet the digital imaging needs of animal care providers.

- Exceptional image quality with digital sensors
- Compatible with phosphor plates and film
- 0.4 mm focal spot; 60, 65 or 70 kV; 4,5,6 or 7 mA
- Easy-to-read LCD display
- Unique settings menu with 30 pre-programmed techniques and patient-type selections
- Tube head positioning handle; and control panel that can be mounted in a separate location.
- 56", 66", 76" and 82" or mobile systems available
- Two-year warranty



WALL MOUNTED

DCV5-G2X/H	56" Integrated Arm	\$6,682.00
DCV6-G2X/H	66", Integrated Arm	\$6,682.00
DCV7-G2X/H	76", Integrated Arm	\$6,682.00
DCV8-G2X/H	82", Integrated Arm	\$6,472.00
ASAW-GT	Laptop Tray for Wall-mount X-ray	\$515.00

MOBILE

DCVM-G0X/H	Mobile, Integrated Arm	\$8,447.00
ASAM-GT	Laptop Tray for Mobile X-ray	\$515.00
ASAM-GT/L	Laptop with Imaging Software and Laptop Tray	\$2,184.00
30-A2040	Handswitch (comes with all units)	\$124.00
WARRX1	X-ray Factory Warranty Extension, One Year	\$501.00
WARRX2	X-ray Factory Warranty Extension, Two Years	\$905.00



Dental Radiography Software

Midmark Radiography solutions feature proprietary imaging software that is easy to learn and use. Whether you want to acquire, enhance or store images, our intuitive software includes canine and feline tooth templates organized using the Triadan System. The software is also DICOM compliant and seamlessly integrates with practice management systems and PACS servers.

- Ongoing support and lifetime upgrades
- Exceptional image quality
- Easy to learn interface
- Simplified image acquisition
- Customizable templates
- Native DICOM format
- Easy-to-use image-enhancing tools
- Interfaces with practice management software
- Print custom take home reports
- Email option from work surface
- Modality worklist compatibility

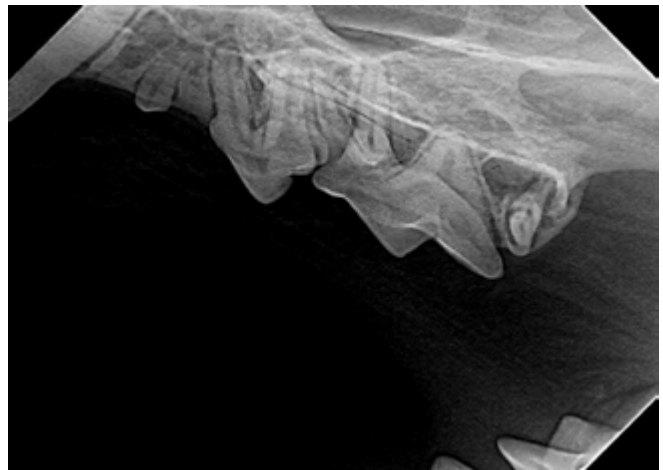

Feline



Canine

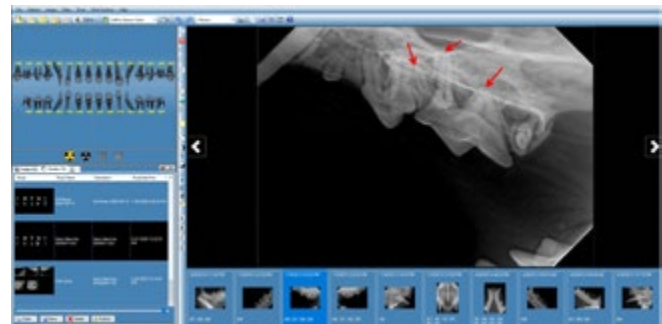
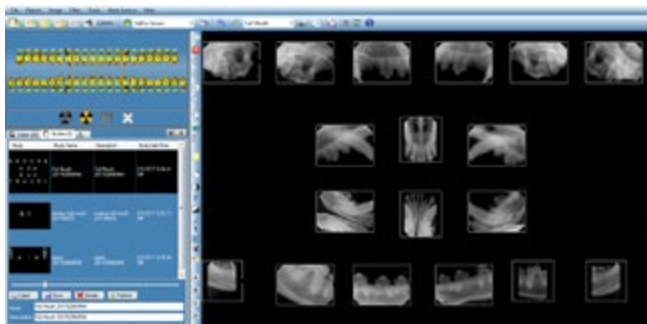
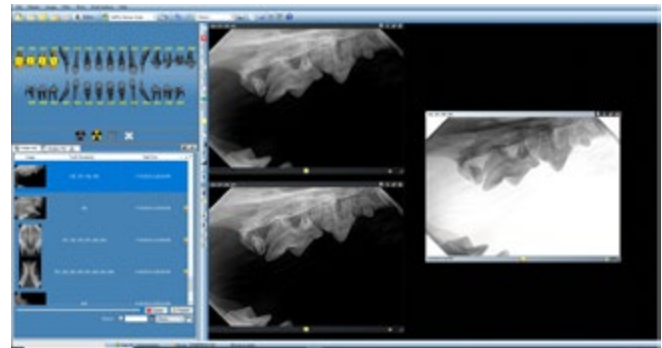
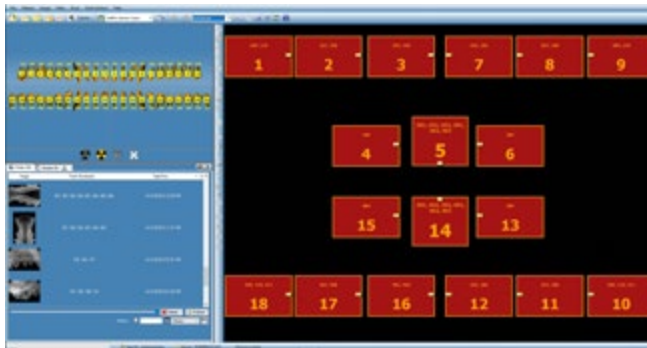

Instrument Processing

Midmark instrument processing solutions use a combination of simple-to-use, automated devices designed to produce a more efficient, standardized workflow and consistent outcomes.



midmark

Instrument Processing

QuickClean® Ultrasonic Cleaners

Providing powerful cleaning and consistent results, QuickClean® Ultrasonic Cleaners are an ideal solution for your animal hospital. Cutting-edge technology and streamlined controls help you efficiently and safely process instruments, reducing the time and effort needed for cleaning.

- Simple to operate
- Digital LCD control panel
- Preset cycles and fluid-level sensor
- Frequency-leap technology helps ensure consistent cleaning
- Full-size safety basket
- Three tabletop and two recessed models
- 3-year limited warranty

QC1-01	QuickClean® 1.2 Gal Tabletop	\$1,311.00
QC3-01	QuickClean® 3.3 Gal Tabletop	\$2,251.00
QC3R-01	QuickClean® 3.3 Gal Recessed	\$2,537.00
QC6-01	QuickClean® 6.6 Gal Tabletop	\$3,451.00
QC6R-01	QuickClean® 6.6 Gal Recessed	\$3,681.00
002-10007-00	QC1 Repl. Safety Basket	\$98.00
002-10008-00	QC3/QC3R Repl. Safety Basket	\$152.00
002-10009-00	QC6/QC6R Repl. Safety Basket	\$217.00
9A612001	QC1 Beaker Accessory Kit	\$166.00
9A613001	QC3/QC3R Beaker Accessory Kit	\$222.00
9A614001	QC6/QC6R Beaker Accessory Kit	\$284.00



QC1-01



QC3-01



QC6-01

Specifications	QC1-01	QC3-01	QC6-01
Capacity	1.2 Gal/4.5 L	3.3 Gal/12.5 L	6.6 Gal/25 L
Overall Length	13.5" (34.5 cm)	14.7" (37.5 cm)	21.6" (55 cm)
Overall Width	10.2" (26 cm)	16.5" (42 cm)	16.5" (42 cm)
Overall Height	10.4" (26.5 cm)	10.4" (26.5 cm)	14.3" (36.5 cm)
Tank Size	11.8" L x 5.9" W x 5.9" H (30 x 15 x 15 cm)	13" L x 11.8" W x 5.9" H (33 x 30 x 15 cm)	19.9" L x 11.8" W x 7.8" H (50.5 x 30 x 20 cm)
Recessed Unit Cut Out Size	N/A	15.55" x 14.37" (39.5 x 36.5 cm)	22.48" x 14.37" (57.1 x 36.5 cm)
Tabletop Unit Weight	12.7 lbs (5.76 kg)	18.6 lbs (8.42 kg)	29.6 lbs (13.44 kg)
Tabletop Shipping Weight	14.6 lbs (6.64 kg)	20.9 lbs (9.50 kg)	32.6 lbs (14.78 kg)
Recessed Unit Weight	N/A	22.3" lbs (10.10 kg)	32.9 lbs (14.92 kg)
Recessed Unit Shipping Weight	N/A	24.6 lbs (11.18 kg)	35.8 lbs (16.62 kg)
Electrical Requirements	Input: 115VAC +/- 10%, 60 Hz, 110W, 1.0A Output: 100W	Input: 115V +/- 10%, 60 Hz, 210W, 1.8A Output: 200W	Input: 115VAC +/- 10%, 60 Hz, 410W, 3.6A Output: 400W

Midmark Sterilizers

Midmark sterilizers are designed to be safe, easy to use and dependable. Every sterilizer is inspected and ASME* certified by a third-party-licensed inspector, ensuring the reliability for which Midmark is known. The Midmark M9® and M11® Steam Sterilizers are designed, manufactured and supported in the US, with decades of manufacturing experience built into each one.

Midmark M11® Steam Sterilizer

Our Largest Standard Tabletop Sterilizer

- Automatic-opening Door
- Minimum Counter Space Required: 21" (53.3 cm) D x 17.8" (45.2 cm) W x 18.1" H (50.0 cm)
- Chamber Size: 11" diameter (28 cm) x 18" depth (45.7 cm)
- Weight: 99 lb (44.9 kg)
- Shipping Weight: 131 lb (59.4 kg)

M11-043	Midmark M11 Steam Sterilizer	\$6,966.00
M11-043-P	Midmark M11 Steam Sterilizer with Printer	\$7,583.00
M11-043-DL	Midmark M11 Steam Sterilizer with Data Logger	\$7,882.00



Instrument Processing

Midmark M9® Steam Sterilizer

- Automatic-opening Door
- Minimum Counter Space Required: 17.88" (45.4 cm) D x 15.3" (38.9 cm) W x 16.1" (40.9 cm) H
- Chamber Size: 9" diameter (22.9 cm) x 15" depth (38.1 cm)
- Weight: 73 lb (33.1 kg)
- Shipping Weight: 81 lb (36.7 kg)

M9-043	Midmark M9 Steam Sterilizer	\$5,963.00
M9-043-P	Midmark M9 Steam Sterilizer with Printer	\$6,607.00
M9-043-DL	Midmark M9 Steam Sterilizer with Data Logger	\$6,880.00



For Sterilizer Accessories, see page 97.

* Meets the requirements of ASME Boiler and Pressure Vessel Code. See Midmark.com for details.

Midmark Sterilizer Accessories

	Pouch Rack	Cool Hand Tool	External Condensing Tank	Printer	Deep Tray	Horizontal Cassette Rack	Vertical Cassette Rack
M9®	•	•	•	•	•		
M11®	•	•	•	•	•	•	•

Racks

9A215001 (B) M11® Horizontal Cassette Rack - Holds Four Large and Four Small Cassettes \$195.00

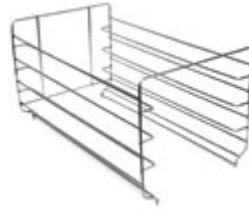

B: Horizontal Cassette Rack
15.2"L x 8.6"W x 8"H

9A215002 (C) M11® Vertical Cassette Rack - Holds Four Large and Four Small Cassettes \$195.00



C: Vertical Cassette Rack
15.5"L x 9.25"W x 8.75"H

Accessories

9A307001 (E) Cool Hand Tool (Tray and Cassette Removal Tool) \$38.00



E: Cool Hand Tool 8.5"L

9A599001 (F) M11®/M9® Thermal Printer \$643.00



F: M11®/M9® Thermal Printer

002-0396-00 (G) SpeedClean (One 16 oz. bottle) \$28.00

002-0396-05 One Case SpeedClean (Twelve 16 oz. bottles) \$139.00

9A682001 (H) Sterilizer Data Logger \$916.00



H: Sterilizer Data Logger

002-10502-00 (I) Data Logger USB Device \$47.00



I: Data Logger USB Device



G: SpeedClean 8"H

Instrument Processing Workflow

Follow established instrument processing best practices, outlined here, to create a smooth workflow from dirty to clean that will help contain contamination and maximize the efficiency of your instrument cleaning and sterilization process. For more information on our Synthesis Cabinetry, see pages 64-73.



STEP 1

Receiving, Cleaning and Decontamination: Reusable instruments, supplies and equipment should be received, cleaned and decontaminated in one section of the processing area.

STEP 2

Preparation and Packaging: Cleaned instruments and other supplies should be inspected; assembled into sets or trays; and wrapped or packaged for sterilization.

STEP 3

Sterilization: The sterilization area should include the sterilizer and related supplies with adequate space for loading, unloading and cool down.

STEP 4

Monitoring/Sterility Assurance: Use mechanical, chemical and biological monitoring to ensure effectiveness of the sterilization process.

STEP 5

Storage: The storage area should contain space for sterile items and disposable items. Supplies and instruments should not be stored under sinks or in other locations where they might become wet.

Lighting + Scales

The advanced lighting design of Midmark operating lights delivers the true, reduced-shadow white light you need to properly match shades, see details and diagnose tissue. Various mounting configurations are available to meet your design needs.

The accuracy of Midmark scales is dependable and precise up to 330 lb.



Procedure Lights

Midmark® 255 LED Procedure Light

- Significantly more light intensity than similar products at 7,500 footcandles, an excellent color rendering index of 95 out of 100, and a color temperature of 4,400 K
- Counterbalanced design allows easy positioning of the light, precisely where you want it, without drifting
- 16 LEDs reflecting evenly off of 1,040 reflective facets will reduce the disruption of shadows while you work, producing an even distribution of light for uninterrupted illumination
- Turn the light on/off and adjust light intensity from controls on each side of the light head
- LEDs have 100 times longer life than most halogen lamps while consuming less energy, resulting in significant savings year after year
- Sleek contours, a sealed light head and an autoclavable handle help save maintenance time and increase product life
- ANSI/AAMI ES 60601-1, CAN/CSA C22.2 No. 60601-1, EN 60601-1-2, EN 60601-1, RoHS, NFPA 99, EN 60601-2-41



255 LED PROCEDURE LIGHT, SINGLE, CEILING MOUNT

255-021	255 LED Procedure Light Single Mount, 8' (2.4m) ceiling	\$3,812.00
255-022	255 LED Procedure Light Single Mount, 9' (2.7m) ceiling	\$3,812.00

255 LED PROCEDURE LIGHT, MOBILE

255-025	255 LED Procedure Light, Mobile	\$3,812.00
----------------	---------------------------------	------------

CEILING MOUNT ADAPTER KIT

- Converts an 8' or 9' system to a 10' (3.05 m) mount height
- One required per light arm

002-1865-00	10' Ceiling Mount Adapter Kit	\$385.00
9A584001	Conversion Kit With Cover	\$162.00

The following model numbers are recommended based on the following ceiling heights (measured from the bottom of the ceiling surface to the floor).

Below 8'	255-025	Mobile Procedure Light
8' to 9'	255-021, 255-023	8' Single or Dual Light
9' to 10'	255-022, 255-024	9' Single or Dual Light
Above 10'	255-025, 002-1865-00	Mobile Procedure Light or 10' Ceiling Mount Adapter Kit

MIDMARK® 255 LED PROCEDURE LIGHT, DUAL CEILING MOUNT

- 255-023 255 LED Procedure Light, Dual Mount, 8' (2.4m) ceiling \$7,622.00
- 255-024 255 LED Procedure Light, Dual Mount, 9' (2.7m) ceiling \$7,622.00



MIDMARK® 255 LED PROCEDURE LIGHT, WALL MOUNT

- 255-026 255 LED Procedure Light, Wall Mount \$5,134.00



Exam Light

Midmark 250, LED Exam Light

- LED technology for up to 25,000 hours of useful bulb life
- 45% less energy consumed than equivalent halogen lights
- 4,000 K color temperature
- 1,800 footcandle intensity (19,375 lux)
- Exam light weight: 20 lb
- Shipping weight: 25 lb

- 250-003 250 LED Exam Light \$456.00
- 9A621001 Caster Base Accessory \$37.00



Caster Base Accessory

Treatment Lights

Midmark 120, LED Treatment Light

- Light intensity: 40,000 lux, at a distance of 39.4"
- Color temperature: 4,500 K
- Light head diameter: 11.4"
- Made up of 12 LEDs
- Life cycle of LEDs: >60,000 hours
- 3-year limited warranty

122-1203-13	120 Single Ceiling Mount Light	\$3,036.00
122-1203-14	120 Dual Ceiling Mount Light	\$7,834.00
122-1203-12	120 Wall Mount Light	\$2,495.00
122-1203-11	120 Mobile Light	\$2,655.00
122-9240-93	120 Sterilizable Handle w/ adapter	\$196.00
122-9240-94	Sterilizable Handle Only	\$82.00



Midmark 130, LED Treatment Light

- Light intensity: 60,000 lux, at a distance of 39.4"
- Color temperature: 4,500 K
- Light head diameter: 13"
- Made up of 19 LEDs
- Life cycle of LEDs: >60,000 hours
- 3-year limited warranty

122-1303-13	130 Single Ceiling Mount Light	\$3,794.00
122-1303-14	130 Dual Ceiling Mount Light	\$9,346.00
122-1303-12	130 Wall Mount Light	\$3,253.00
122-1303-11	130 Mobile Light	\$3,409.00
122-9240-93	130 Sterilizable Handle w/ adapter	\$196.00
122-9240-94	Sterilizable Handle Only	\$82.00



Scales

LCD Cat Scale

- Spacious platform 20" x 14"
- Accommodates large cats
- Dependable and accurate
- Easy-to-read 1" LCD display
- Built-in sleep function
- Ounces or kilograms – weighs in 0.5 ounce or 10 gram increments
- 44 pound/ 20 kilogram capacity
- Powered with AC adapter or one 9-volt battery

110-5090-07 LCD Cat Scale \$404.00



Platform Scale

- Post mount and no slip mat included with scale
- Stainless steel platform with drip edge
- The stainless steel provides long-lasting durability and easy wipe-down cleaning
- HOLD key on the remote display allows the animal's weight to be retained after leaving the platform
- Large 44" L x 22" W size with 330 lb capacity is ideal for weighing medium to large animals
- AC or battery power with low battery indicator and auto-off feature to extend battery life
- Adjustable feet for easy leveling
- Easy-to-read backlit display
- Tare feature for weighing using baskets or crates
- Can be mounted on a variety of lift tables

110-3110-00 Platform Scale \$1,353.00



Midmark AcademySM

Midmark is the trusted name in veterinary, dentistry, anesthesia and monitoring solutions that help create better care experiences. Training provided in your hospital, on your equipment, with your entire staff optimizes consistent standards of care across your hospital. Our RACE-approved training courses are delivered by industry-leading dental and anesthesia specialists who will teach you how to achieve the highest level of dental and anesthesia excellence to grow your practice and improve the health of your patients.



Dental Radiography Positioning Training

Comprehensive, hands-on, half-day training performed in your clinic by a member of the Midmark Animal Health Training and Education Network.

This in-clinic training will help your entire staff become more efficient with acquiring those challenging views.

Training topics include:

- Generator usage
- Midmark imaging software training
- Positioning techniques for both canine and feline patients
- How to overcome common positioning mistakes
- Proper maintenance and storage techniques

Veterinarians and credentialed technicians who complete this session will earn four hours of CE credits* for dental radiography and positioning training.



4 CE Credit Hours*

VI-RAD Dental X-ray Positioning Training \$1,995**

To set up your training session or if you have any questions, please contact your local distributor representative or email: midmark-academy@midmark.com

Cleaning, Probing and Charting Training

This training will help participants become familiar with best practices for dental cleaning, probing and charting.

Training topics include:

- Preparation—including rinse, before and after photos, proper attire and safety
- Execution—including tools, sub/supra-gingival scaling, polishing, probing and charting
- Instrument sharpening and care
- Common pathologies
- Anatomy review and Triadan numbering system
- Probing technique
- Proper use and maintenance of your Midmark high-speed system

Veterinarians and Veterinary Technicians who complete this session will earn four hours of CE credits* for Dental Cleaning, Probing and Charting Training.

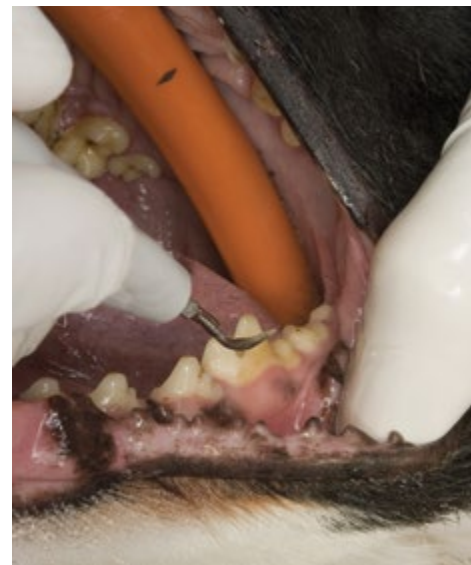

4 CE Credit Hours*

VI-CPC Cleaning, Probing & Charting Training \$1,995**

VI-RDCP Both Courses Above If Taken on the Same Day \$3,395

*These programs were reviewed and approved by the AAVSB RACE program for four hours of continuing education in jurisdictions which recognize AAVSB RACE approval. Please contact the AAVSB RACE program if you have any comments/concerns regarding a program's validity or relevancy to the veterinary profession. Provider #436.

**Pricing for Continental US only.

Anesthesia Monitoring 101

Our comprehensive, hands-on, half-day anesthesia monitoring training is provided in your clinic by a member of the Midmark Animal Health Training and Education Network.

This training from Midmark Animal Health will help participants become familiar with best practices for operating and maintaining their anesthesia and monitoring equipment.

Training topics include:

- Anesthesia machine theory of operation, function of components and flow of gases
- Proper equipment maintenance for long-term performance and better patient outcomes
- Overview of ACVAA anesthetic monitoring guidelines for small animals
- Five-parameter, hands-on monitoring including circulation, oxygenation and ventilation
- How vital signs are measured and what the readings mean

Veterinarians and credentialed technicians who complete this session will earn four hours of CE credits* for Anesthesia Monitoring 101. Class size is limited to 10 attendees.

VI-AMT Anesthesia Monitoring 101 \$1,995**



4 CE Credit Hours!*

To set up your training session or if you have any questions, please contact your local distributor representative or email: midmark-academy@midmark.com

Anesthesia Monitoring 201

Building on the skills of our 101 lab, our 201 lecture is provided in your clinic by a member of the Midmark Animal Health Training and Education Network.

Following the prerequisite Anesthesia Monitoring 101 dry lab, this lecture will help participants learn the keys to completing a successful anesthetic case.

Training topics include:

- Review of ACVAA/AAHA monitoring/anesthesia guidelines
- Setting up the patient for an anesthetic case
- Balanced anesthesia/pain management best practices
- Troubleshooting vital signs readings and anesthesia complications
- Developing an anesthesia record-keeping plan

Veterinarians and credentialed technicians who complete this session will earn four hours of CE credits* for Anesthesia Monitoring 201. Class size is limited only by the size of the classroom space.

VI-AMT2 Anesthesia Monitoring 201 \$1,995**

VI-AMT3 Anesthesia Monitoring 101 + 201 (scheduled on same day) \$3,395**



4 CE Credit Hours!*

*This program was reviewed and approved by the AAVSB RACE program for four hours of continuing education in jurisdictions which recognize AAVSB RACE approval. Please contact the AAVSB RACE program if you have any comments/concerns regarding this program's validity or relevancy to the veterinary profession. Provider #436.

**Prices vary for clinics located outside the Continental United States.

Midmark AcademySM Clinical Training Packages

GOLD PACKAGE DENTISTRY TRAINING*

Dentistry success requires more than just the right equipment—it takes a comprehensive team. When your entire team is thoroughly trained, you can build a foundation for long-term, sustained growth and success for your dental program. This two-day in-clinic training event begins with the Dentistry Best Practices interactive workshop for your entire staff, customized to your practice and designed to engage your team in launching a comprehensive dental program proven to double your dentistry within 12 months.* The second day clinical lab will prepare your veterinarians and technicians with the skills and confidence to perform comprehensive oral radiographic exam ("CORE") procedures and to treat underlying oral disease with fundamental techniques in pain management and oral surgery.

Following this approach, more than 150 hospitals nationwide* have experienced results that include:

- Better client compliance
- Improved patient outcomes
- Team empowerment
- Reduced turnover
- Practice growth

Midmark AcademySM in-clinic training is a lasting investment in better care. Learn more at MidmarkAcademy.com or contact midmark-academy@midmark.com. Talk to your distributor partner about available financing.



Part Number	Course Package Description	Price
002-1640-10 GOLD	<p>Dental Best Practices Workshop [RACE 8 Hours]</p> <ul style="list-style-type: none"> • Dentistry—what it is and why it is important • Oral Anatomy—review of skull and tooth anatomy • Lift-the-Lips Practice—steps to a complete awake oral exam and review of oral pathology • CORE Procedure—comprehensive oral and radiographic evaluation step by step • CORE Team—who does what, where, when and how from recommendation to recheck • Implementation—from marketing and client education to brainstorming <p>Level 1 Clinical Dentistry Lab (for the Veterinarian) [RACE 8 Hours]—on site with board-certified veterinary dentist; 5 veterinarians included</p> <ul style="list-style-type: none"> • Best Practices in Pain Management • Best Practices in Periodontal Surgery • Best Practices in Oral Surgery • Hands-on Lab/Practice in Oral Surgery, Periodontal Surgery and/or Regional Nerve Blocks <p>Dental Radiograph Positioning, Cleaning, Probing + Charting Lab [RACE 8 Hours]—10 attendees max</p> <ul style="list-style-type: none"> • Canine and Feline Dental Radiography Positioning Techniques • Common Positioning Errors—troubleshooting and understanding their causes and resolutions • Functionality of the X-Ray Generator • Best Practices for Cleaning, Probing and Charting • Nomenclature and Recognizing Pathology • Hands-on Practice Performing Supra/Subgingival Scaling and Polishing Teeth • Hand Instrumentation, Care and Sharpening Techniques • Functionality and Care of the Dental Machine and Handpieces <p>Free Benchmarking Survey—prerequisite for customized training</p> <p>Free Dental Success Kit—\$414 value</p>	\$16,995.00

*Based on results from the Midmark Dental Study

Midmark AcademySM Clinical Training Packages

Part Number	Individual Course Descriptions	Price
VI-AMT	Anesthesia + Monitoring 101 (for veterinarians and technicians) [RACE 4 Hours]—10 attendees max	\$1,995.00
VI-AMT2	Anesthesia + Monitoring 201 (for veterinarians and technicians) [RACE 4 Hours]	\$1,995.00
VI-AMT3	Anesthesia + Monitoring 101 + 201 Full-Day, In-Clinic Training [RACE 8 Hours]—10 attendees max for 101; lecture format for 201, no max for attendees (201)	\$3,395.00
VI-AMT-ADD	Introduction to Mechanical Ventilation (add-on only) [RACE 2 hrs]—10 attendees max	\$550.00
VI-RAD	Dental Radiography Positioning Lab [RACE 4 Hours]—on site with VTS (Dentistry); 10 attendees max	\$1,995.00
VI-CPC	Cleaning, Probing + Charting Lab [RACE 4 Hours]—on site with VTS (Dentistry); 10 attendees max	\$1,995.00
VI-RDCP	Dental Radiography Positioning, Cleaning, Probing + Charting Full-Day Lab [RACE 8 Hours]—10 attendees max. In-Clinic Training on Client's Equipment—specimens not provided	\$3,395.00
VI-RAD-ADD	Regional Dental Anesthetic Blocks Lab (add-on only) [RACE 2 Hours]—10 attendees max, Requires 1 Veterinarian participant	\$550.00
VI-CPC-ADD	Dental Technician Add On Training, 2 Hours	\$525.00
VI-AMT-SIM	Anesthesia Simulation Workshop	\$6,299.00
002-1640-00 SILVER PACKAGE	Dental Best Practices Workshop [RACE 8 Hours] Free Benchmarking Survey—prerequisite for customized training Free Dental Success Kit—\$399 value	\$6,995.00
002-1640-20 PLATINUM PACKAGE	<p>Dental Best Practices Workshop [RACE 8 Hours]</p> <ul style="list-style-type: none"> • Dentistry—what it is and why it's important • Oral Anatomy—review of skull and tooth anatomy • Lift-the-Lips Practice—steps to a complete awake oral exam and review of oral pathology • CORE Procedure—comprehensive oral and radiographic evaluation step by step • CORE Team—who does what, where, when and how from recommendation to recheck • Implementation—from marketing and client education to brainstorming <p>Level 1 Clinical Dentistry Lab (for the Veterinarian) [RACE 8 Hours]—on site with Board Certified Veterinary Dentist; 5 veterinarians included</p> <ul style="list-style-type: none"> • Best Practices in Pain Management • Best Practices in Periodontal Surgery • Best Practices in Oral Surgery • Hands-on Lab/Practice in Oral Surgery, Periodontal Surgery and/or Regional Nerve Blocks <p>Dental Radiograph Positioning, Cleaning, Probing + Charting Lab [RACE 8 Hours]—10 attendees max</p> <ul style="list-style-type: none"> • Canine and Feline Dental Radiography Positioning Techniques • Common Positioning Errors—troubleshooting and understanding their causes and resolutions • Functionality of the X-Ray Generator • Nomenclature and Recognizing Pathology • Common Pathology Found in Probing—recognizing and charting it properly • Hands-on Practice Performing Supra/Subgingival Scaling and Polishing Teeth • Hand Instrumentation, Care and Sharpening Techniques • Functionality and Care of the Dental Machine and Handpieces <p>Full-Day, On-Site Follow-up with Board Certified Veterinary Dentist</p> <p>Full-Day, On-Site Follow-up with VTS (Dentistry)</p> <p>Free Benchmarking Survey—prerequisite for customized training</p> <p>Free Dental Success Kit—\$399 value</p>	\$27,995.00

Monitoring

State-of-the-art Midmark diagnostic and multiparameter monitors provide the gold standard in efficient, accurate patient monitoring. Our family of total monitoring solutions features Cardell® BP technology, veterinary-specific algorithms and innovative, staff-friendly capabilities that make it easier to get reliable, precise readings, even in small companion animals.



midmark

Multiparameter Monitor

Checklist

- IF Enter initials with keyboard
- Perform Leak Test on Anesthesia Machine
- Check that APL valve is open on anesthesia machine
- Confirm that soda lime absorbent is not expired
- Calculate Intra - Op Drugs
- Calculate Emergency Drugs
- Confirm vaporizer is filled
- Check O2 supply
- Check patient's history
- Open slot <only appears if user edits>
- Open slot <only appears if user edits>

HR BPM
60
from ECG

SpO2 % PR BPM
100 **60**

CO2 mmHg TEMP °F
EtCO2 InCO2 T1 T2 TD
38 **2** **97.7** **97.8** **0.1**
RR **30**

NIBP mmHg
1min **120 / 80** Large **93**
PR 60

Pat.Set Settings Alarms Pause NIBP Suspend Freeze Displays Trend Print Lock AM 09:31:12 Tuesday

Multiparameter Monitoring

Midmark Multiparameter Monitor

With decades of clinical experience responding to common anesthetic issues, we have designed enhanced features to help your team avoid pitfalls and prevent anesthetic complications. In addition, the Midmark Multiparameter Monitor features Cardell® blood pressure technology, veterinary-specific algorithms and innovative, staff-friendly capabilities.

With the right monitor, you can help provide safer, more efficient care, giving you and your patients' families peace of mind.

- 12.1" touch screen display
- Pre-procedure checklist
- CO₂ soda lime absorbent reminder
- Exclusive Cardell® BP technology
- BP screening mode
- Nellcor® SpO₂
- ECG and CO₂ libraries
- CO₂ monitoring availability
- Masimo® Multigas availability
- Optional 3-channel printer
- Optional Invasive BP
- ECG data export capabilities
- USB port for downloading data and uploading software
- 2-year limited warranty



Optional Printer Shown



Cable-side View

8019-001	Midmark Multiparameter Monitor with Printer	\$7,696.00
8019-002	Midmark Multiparameter Monitor without Printer	\$7,451.00
8019-003	Midmark Multiparameter Monitor with Invasive BP and Printer	\$9,722.00
C-STAT5	CAPNOSTAT® Mainstream CO ₂ Probe	\$2,880.00
LOFLO	LoFlo™ Sidestream CO ₂ Module	\$2,880.00
002-1745-00	Kit, Masimo Multigas Mainstream Sensor and Adapters	\$9,639.00
002-1746-00	Kit, Masimo Multigas Sidestream Sensor and Adapter	\$9,639.00



Back View



Mainstream Multigas



Sidestream Multigas



Mainstream CO₂ Probe



Sidestream CO₂ Module

Additional monitoring accessories are available at midmarkserviceparts.com.

For monitor mounts, see page 113.

Diagnostic Monitoring

Cardell® Insight Diagnostic Monitor

Designed to be compact, lightweight, and durable, with an intuitive touch screen interface for ease of use. The Cardell® blood pressure technology provides accurate and reliable blood pressure readings with optional Nellcor® SpO₂ monitoring.

Popular uses include:

- Examination, treatment, surgery, recovery
- Monitoring patients as they are moved around your hospital
- Mobile practices and field monitoring purposes

Features:

- 3 animal-specific alarm settings provide quicker patient set up
- Bright 7" touchscreen display with anti-glare coating for better viewing from any angle
- Fixed touch selection provides quick and easy access to most used functions
- 10-hour battery life with 5-minute auto mode for blood pressure allows for increased mobility
- 2-year limited warranty

8014-001	Cardell® Insight Diagnostic Monitor, NIBP	\$3,107.00
8015-001	Cardell® Insight Diagnostic Monitor, NIBP, SpO ₂	\$4,438.00

Additional monitoring accessories are available at midmarkserviceparts.com.

For monitor mounts, see page 115.



Monitor Mounts

With mobile, anesthesia, table, and other mounting configurations, we are sure to have the monitoring mounting solution that fits your clinic needs.

8014/8015/8019 SERIES MONITORS

8008-005	Monitor Mount, Mobile Stand, for 8014/8015/8019	\$648.00
9A465009	Monitor Mount, VMS Plus, for 8014/8015/8019	\$209.00
9A465010	Monitor Mount, Pole, for 8014/8015/8019	\$483.00
9A465011	Monitor Mount, Stud, for 8014/8015/8019	\$440.00
9A465012	Monitor Mount, Wall, for 8014/8015/8019	\$503.00
8008-006	Monitor Mount, CM Lift Table, for 8014/8015/8019	\$876.00



Mobile Stand



Stud Mount

MAX-12 MONITORS

8008-001	Monitor Mount, Mobile Stand, for Max-12	\$648.00
9A465001	Monitor Mount, VMS Plus, for Max-12	\$209.00
9A465005	Monitor Mount, Stud, Max-12	\$440.00
9A465007	Monitor Mount, Wall, Max-12	\$503.00
8008-003	Monitor Mount, CM Lift Table, for Max-12	\$876.00

9400/9500 SERIES MONITORS

8008-002	Mobile Stand, for 9400/9500/8013	\$648.00
9A465002	Monitor Mount, VMS Plus, for 9400/9500/8013	\$209.00
9A465004	Monitor Mount, Pole, for 9400/9500/8013	\$483.00
9A465006	Monitor Mount, Stud, for 9400/9500/8013	\$440.00
9A465008	Monitor Mount, Wall, for 9400/9500/8013	\$503.00
8008-004	Monitor Mount, CM Lift Table, for 9400/9500/8013	\$876.00



VMS[®] Plus

Monitor Accessories

Each monitor is equipped with the accessories necessary to allow for full monitoring capability, including BP cuffs, probes, sensors and connecting cables appropriate for the parameters chosen. The accessories have been carefully sourced to promote optimum performance with animal patients.

ECG FOR 8019

016-10177-00	ECG Trunk Cable	\$229.00
016-10178-00	3-Lead ECG Cable/Lead/Clip Set	\$393.00
016-1604-00	3-Lead ECG Wire Set	\$117.00
016-10179-00	5-Lead ECG Cable/Lead/Clip Set	\$393.00
016-1603-00	5-Lead ECG Wire Set	\$117.00
ECG-A3	Copper ECG Alligator Clip	\$10.00
016-10232-00	Extra Small Esophageal Probe	\$255.00
016-10233-00	Esophageal Probe – S	\$255.00
016-10234-00	Esophageal Probe – L	\$255.00

ECG FOR 8013

016-1743-00	DEFIB ECG Trunk Cable	\$216.00
016-1742-00	3-Lead ECG Cable/Lead/Clip Set	\$393.00
016-1604-00	3-Lead ECG Wire Set	\$117.00
016-1741-00	5-Lead ECG Cable/Lead/Clip Set	\$380.00
016-1603-00	5-Lead ECG Wire Set	\$117.00
ECG-A3	Copper ECG Alligator Clip	\$10.00
EP-XS	ECG Esophageal Probe – XS	\$255.00
EP-S	ECG Esophageal Probe – S	\$255.00
EP-L	ECG Esophageal Probe – L	\$255.00

TEMPERATURE PROBE FOR 8019

016-10164-00	ESOPH/RECTAL Temperature Probe	\$69.00
--------------	--------------------------------	---------

TEMPERATURE PROBE FOR 8013

590004	ESOPH/RECTAL Temperature Probe	\$196.00
--------	--------------------------------	----------

NIBP/IBP FOR 8019

NIBP-TUBE	NIBP Inflation Tube	\$53.00
016-10180-00	IBP Trunk Cable	\$90.00
016-1587-00	Disposable IBP Transducer and Administrative Set	\$58.00

NIBP/IBP FOR 8013

01-03-0162	6ft Air Hose (NIBP Hose)	\$58.00
650-208	IBP Trunk Cable	\$60.00
016-1587-00	Disposable IBP Transducer and Administrative Set	\$58.00

BP CUFFS FOR 8013/8014/8015/8019

SV1	Small Animal BP Cuff #1	\$12.00
SV2	Small Animal BP Cuff #2	\$12.00
SV3	Small Animal BP Cuff #3	\$12.00
SV4	Small Animal BP Cuff #4	\$12.00
SV5	Small Animal BP Cuff #5	\$12.00
SV8	Large Animal BP Cuff #8	\$31.00
SV10	Large Animal BP Cuff #10	\$33.00
SV600	Set of Small Animal BP Cuffs	\$74.00

Additional monitoring accessories are available at midmarkserviceparts.com.

SpO₂ FOR 8013/8015/8019

01-02-0183	Nellcor DOC-10 SpO ₂ Cable	\$347.00
V-SAT	Nellcor VETSAT SpO ₂ Sensor W/ Lingual Clips	\$432.00
VSC-S	Small Animal SpO ₂ Sensor Clip	\$65.00
VSC-L	Large Animal SpO ₂ Sensor Clip	\$65.00

OTHER

PAPER-4F	Printer Paper, 4 Rolls	\$53.00
----------	------------------------	---------



Cardell® Touch (8013)



Midmark Multiparameter Monitor (8019)

Seating

Soft, comfortable and ergonomically correct seating designed for high-use veterinary applications with several color and accessory options to complement your space.



280 + 282 Client Chairs

Soft, comfortable seating for clients and their companions. Available with or without arms; black frame, a variety of upholstery colors.

- 18.5" / 30" seat widths
- 400 / 650 lb weight capacity

280-001-XXX	280 Client Chair w/o arms	\$400.00
280-002-XXX	280 Client Chair w/arms	\$445.00
282-001-XXX	282 Client Chair w/arms	\$704.00

OPTIONS

Standard Ultra-Premium Upholstery Upcharge	\$111.00
--------------------------------------------	----------



Dental Operator's Stool

- Contoured seat with raised front
- Waterfall front edges
- Up to twelve degrees of forward tilt
- One lever adjustment for locking seat and backrest tilt
- Ratcheted backrest for height adjustment without knobs
- Cylinder Height: Tall - 20.9" to 28.7"; Medium - 16.5" to 22"; Short - 15.25" to 18.3"
- Seat Size: Standard - 17.5" x 16.5"; Small - 16.25" x 16"

153811	Dental Operator's Stool	\$797.00
--------	-------------------------	----------

* Specify cylinder height (Tall, Standard, Short) when ordering



View upholstery colors on page 123.

XXX¹ denotes upholstery color.
View upholstery colors on page 123.

Royal Saddle Plus Chair

The Royal Saddle Plus Chair is designed in a way that is easy to adopt a better sitting posture while working. The small and round backrest gives precise support to the lower back and ensures maximum freedom of movement. The seat is in saddle shape, which means that you are not forced to adopt a 90° sitting angle, but are given the space to adopt a position where the knees are lower than the hips. This open hip angle makes it easier to stretch the back, so that it takes less effort to maintain a good work posture.

102-7400-11	Royal Saddle Plus Chair - Black Licorice	\$1,179.00
102-7400-31	Royal Saddle Plus Chair - Special Color	\$1,364.00



Desk Chair

- Back: 12"w x 13.5"h
- Square seat with waterfall front cushioning 16.5"w x 18"d
- Standard cylinder height 18.5" - 22.5"

102-7200-11	Desk Chair, Black Licorice	\$990.00
102-7200-31	Desk Chair - Special Color	\$1,142.00

Operator Chair

- Back: 10"w x 6.5"h
- Triangular-style seat
- Adjustable foot ring
- Standard cylinder height 21" - 28"

102-7100-11	Chair w/o Arms, Black Licorice (Triangle)	\$905.00
102-7100-31	Chair - Special Color	\$1,058.00
102-9000-11	1D Arm Rest (pair)	\$595.00
102-9000-12	2D Arm Rest (pair)	\$811.00



Operator Chair

- Back: 10"w x 6.5"h
- Saddle-style seat 15"w x 16"d
- Standard cylinder height 21" - 28"

102-7000-11	Chair w/o Arms, Black Licorice (Saddle)	\$905.00
102-7000-31	Chair without arms - Special Color	\$1,058.00
102-9000-11	1D Arm Rest (pair)	\$595.00
102-9000-12	2D Arm Rest (pair)	\$811.00



View upholstery colors on page 124.

Midmark® Stools

270 ADJUSTABLE STOOL

- Black composite five-leg base
- Stool weight: 15 lb
(Weight capacity: 300 lb)
- Shipping weight: 20 lb

270-001-XXX¹ 270 Adjustable Stool (Basic stool, manually adjustable) \$161.00



271 ADJUSTABLE STOOL

- Black composite five-leg base
- Stool weight: 20 lb
(Weight capacity: 225 lb)
- Shipping weight: 25 lb

271-001-XXX¹ 271 Adjustable Stool (Basic stool with back, manually adjustable) \$242.00



272 AIR LIFT STOOL

- Black composite five-leg base
- Stool weight: 15 lb
(Weight capacity: 300 lb)
- Shipping weight: 20 lb

272-001-XXX¹ 272 Air Lift Stool (Basic stool, pneumatically adjustable) \$218.00



273 AIR LIFT STOOL

- Black composite five-leg base
- Stool weight: 20 lb
(Weight capacity: 225 lb)
- Shipping weight: 25 lb

273-001-XXX¹ 273 Air Lift Stool (Basic stool with back, pneumatically adjustable) \$310.00



XXX¹ denotes upholstery color.
View upholstery colors on page 123.

276 AIR LIFT STOOL

- Chrome five-leg base
- Stool weight: 15 lb
(Weight capacity: 350 lb)
- Shipping weight: 20 lb

276-001-XXX¹ 276 Air Lift Stool (Basic stool pneumatically adjustable) \$661.00



277 AIR LIFT STOOL

- Chrome five-leg base
- Stool weight: 20 lb
(Weight capacity: 225 lb)
- Shipping weight: 25 lb

277-001-XXX¹ 276 Air Lift Stool (Basic stool with back, pneumatically adjustable) \$812.00



ACCESSORIES

9A366001-XXX ¹	Backrest Kit	\$201.00
9A367001	Foot Ring, Field Installed (not available on foot-release models)	\$144.00
9A368001	6" Lab Height Ext. Kit (not available on foot-release models)	\$103.00

Additional Charges For Plant-Installed Options

XXX	Ultra-Premium Upholstery	\$142.00
27X-002-XXX ¹	Set of Soft Rubber Casters	\$46.00
27X-003-XXX ¹	Set of Glides (not available on foot-release models)	\$0.00
27X-004-XXX ¹	Set of Locking Casters	\$20.00
27X-005-XXX ¹	Auto-Locking Casters	\$114.00

XXX¹ denotes upholstery color.
View upholstery colors on page 123.

Midmark® Upholstery Selections

Standard Upholstery Colors

Available for: 270, 271, 272, 273, 276, 277 Stools, Dental Operators Stools, 280 and 282 Client Chairs. See pages 119, 121 and 122 for available models.



Ultrafree* Upholstery Colors

Available for: 270, 271, 272, 273, 276, 277 Stools, Dental Doctor's and Technician's Stools, 280 and 282 Client Chairs. See pages 117, 119 and 120 for available models.

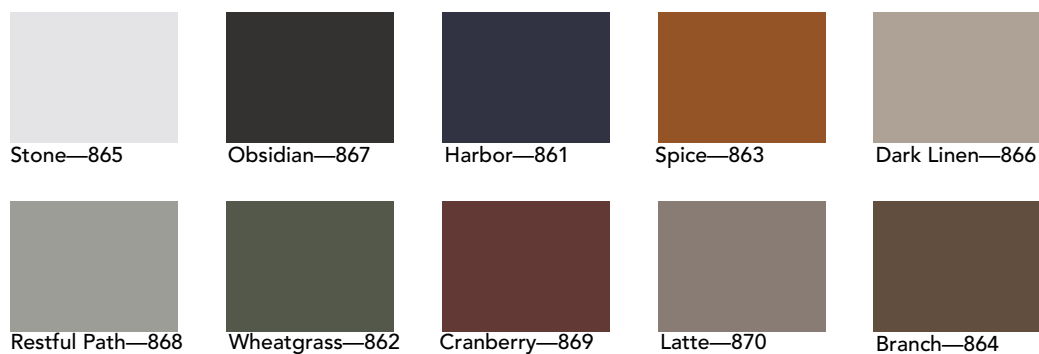

*Ultraleather by UltraFabrics®

Vista Upholstery Colors

Available for: Royal Saddle Plus Chair, Desk Chair, Triangular and Saddle-Style Operator Chairs.
See page 120 for available models.



Stoneware



Buttercup



Shale



City Grey



Maroon



Portobello



Seville



Keystone

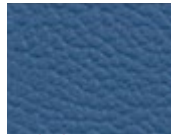

Cobalt

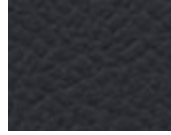

Licorice

Tables, Tubs, Sinks + Grooming

Explore thoughtfully designed solutions that support a safer, more comfortable work environment. Adjustable-height tables and tubs lessen the strain of moving larger animals, while spacious worksurfaces keep your needed materials close at hand. Surgical tables and scrub sinks are meticulously crafted with attention to detail and durable materials for long-term use.



Synthesis® Fixed-Height Tables

Fixed-height tables are crafted from durable stainless steel, with soft-close hinges and adjustable ball-bearing glides to support a quieter environment for patients. Seamless polymer-covered drawer and door panels help prevent spilled liquids from seeping into crevices and joints.

The modular components, part of the Synthesis line, can be reconfigured or expanded to suit your needs, while a variety of panel styles and finishes ensure maintaining your carefully curated aesthetic throughout your facility.

Dry Tables

The Fixed-Height Dry table is a standard 36" height available in numerous configurations to support clinical workflows. Meticulous construction and baked-on epoxy finishes ensure these tables are built to last yet beautiful.



DT4.C791.AN

Island Tables

Fixed-Height Island Tables are ideal for exam spaces and treatment rooms. Island table countertops are available in a variety of stainless steel, Corian® and laminate options, while various door and drawer configurations can also be selected. 44" and 59" lengths suit different room layouts, or custom designs can be explored to help you create the right space for your needs.



IT1.C791.AN

Wet Treatment Tables

Fixed-Height Wet tables easily integrate with your treatment area, with multiple configurations to select. Both shallow and deep tubs are available to support your specific patient populations and treatment needs.

- Perpendicular design allows unrestricted access to both sides of the table.
- Easy-to-clean drains and hair traps simplify maintenance.
- Open-end design simplifies plumbing integration (closed-end option available).



WT62.C791.AS



WT42.C791.AD

Ordering Synthesis® Fixed-Height Tables

The steps below outline how to order Synthesis Fixed-Height table catalog options. Custom configurations are available upon request. Please contact your Midmark Territory Portfolio Manager for more information on the right configuration for your hospital.

STEP 1: SELECT TABLE TYPE AND STORAGE CONFIGURATION

- DT**— Dry Table (Storage configurations options on page 125-126)
- IT**— Island Table (Storage configurations options on page 127-128)
- WT**— Wet Treatment Table (Storage configurations options on page 138-141)

STEP 2: SELECT PANEL STYLE

- C**—Cove
- R**—Renew

STEP 3: SELECT CABINETRY FINISH

Cove Colors:

	Earthen Bronze (metallic)—806
	Venus Silver (metallic)—804
	Flat Iron (metallic)—807
	Pearl Essence (metallic)—805
	Fawn—490
	Whisper—649
	Pebble Grey—216 (PVC Free—793)
	Frost—791

Renew Colors:

	Pebble Grey—216 (PVC Free—793)
------------------------------------------------------------------------------------	-----------------------------------

Renew Handle Insert Colors:

	Pebble Grey—216
	Arctic—244
	Shadow—232
	Fossil Grey—238
	Terra Cotta/Canyon—246
	Clay—234
	Tea Green/Olivine—237
	Silver Sage/Spruce—242
	Moss—230
	Cashmere Blue/Sky—239
	Dusty Blue—233
	Blueberry/Pacific Blue—235
	Navy—231
	Perfect Plum—229
	Black/Raven Wing—312

Table Order Example:

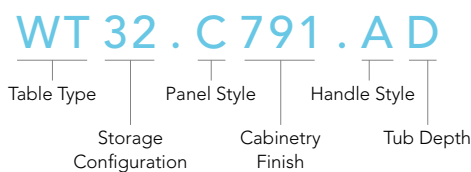

NOTE: For ordering information or to ask about part number items shown above, contact us at **1.844.856.1236**.

[Back to Contents](#)

Synthesis® Fixed-Height Dry Tables

Available in both Cove (C) and Renew (R) door styles.

Select your cabinet color finishes on page 124.

Custom configurations are available upon request. Please contact your Midmark Portfolio Manager for more information on the right configuration for your hospital.

DT 7 . C 791 . A N

Table Type | Panel Style | Handle Style
 Storage Configuration | Cabinetry Finish

- DT1.CXXX.AN 48", RH No Overhang, RH Door, 4" Drawer, (2) 8" Drawer \$2,770.00
- DT1.RXXX.AN 48", RH No Overhang, RH Door, 4" Drawer, (2) 8" Drawer \$2,896.00
- Thermofoil Metallic upcharge \$110.00



DT1.C804.AN

- DT2.CXXX.AN 48", LH No Overhang, LH Door, 4" Drawer, (2) 8" Drawer \$2,770.00
- DT2.RXXX.AN 48", LH No Overhang, LH Door, 4" Drawer, (2) 8" Drawer \$2,896.00
- Thermofoil Metallic upcharge \$110.00



DT2.C806.AN

- DT3.CXXX.AN 48", RH With 18" Overhang, RH Door, 4" Drawer, (2) 8" Drawer \$2,519.00
- DT3.RXXX.AN 48", RH With 18" Overhang, RH Door, 4" Drawer, (2) 8" Drawer \$2,632.00
- Thermofoil Metallic upcharge \$110.00



DT3.R312.AN

- DT4.CXXX.AN 48", LH With 18" Overhang, LH Door, 4" Drawer, (2) 8" Drawer \$2,519.00
- DT4.RXXX.AN 48", LH With 18" Overhang, LH Door, 4" Drawer, (2) 8" Drawer \$2,632.00
- Thermofoil Metallic upcharge \$123.00



DT4.C791.AN

Synthesis® Fixed-Height Dry Tables

Available in both Cove (C) and Renew (R) door styles.¹

Select your cabinet color finishes on page 124.

Custom configurations are available upon request. Please contact your Midmark Portfolio Manager for more information on the right configuration for your hospital.

DT7.C791.AN

Table Type | Panel Style | Handle Style
 Storage Configuration | Cabinetry Finish

- DT5.CXXX.AN 60", RH No Overhang, RH Door, 4" Drawer, (2) 8" Drawer, 4" Drawer, (2) 8" Drawer \$3,846.00
- DT5.RXXX.AN 60", RH No Overhang, RH Door, 4" Drawer, (2) 8" Drawer, 4" Drawer, (2) 8" Drawer \$4,087.00
- Thermofoil Metallic upcharge \$123.00



DT5.R312.AN

- DT6.CXXX.AN 60", LH No Overhang, LH Door, 4" Drawer, (2) 8" Drawer, 4" Drawer, (2) 8" Drawer \$3,846.00
- DT6.RXXX.AN 60", LH No Overhang, LH Door, 4" Drawer, (2) 8" Drawer, 4" Drawer, (2) 8" Drawer \$4,087.00
- Thermofoil Metallic upcharge \$123.00



DT6.C807.AN

- DT7.CXXX.AN 60", RH With 18" Overhang, RH Door, 4" Drawer, (2) 8" Drawer \$2,799.00
- DT7.RXXX.AN 60", RH With 18" Overhang, RH Door, 4" Drawer, (2) 8" Drawer \$2,942.00
- Thermofoil Metallic upcharge \$126.00



DT7.C791.AN

- DT8.CXXX.AN 60", LH With 18" Overhang, LH Door, 4" Drawer, (2) 8" Drawer \$2,799.00
- DT8.RXXX.AN 60", LH With 18" Overhang, LH Door, 4" Drawer, (2) 8" Drawer \$2,942.00
- Thermofoil Metallic upcharge \$126.00



DT8.C804.AN

NOTE: For ordering information or to ask about part number items shown above, contact us at 1.844.856.1236.

[Back to Contents](#)

Synthesis® Fixed-Height Island Tables

Available in both Cove (C) and Renew (R) door styles.

Select your cabinet color finishes on page 124.

Custom configurations are available upon request. Please contact your Midmark Portfolio Manager for more information on the right configuration for your hospital.

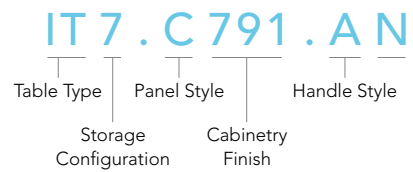

IT1.CXXX.AN	44", (3) 4" Drawer, 8" Drawer, 4" Drawer, RH Door	\$3,112.00
IT1.RXXX.AN	44", (3) 4" Drawer, 8" Drawer, 4" Drawer, RH Door	\$3,342.00
	Thermofoil Metallic upcharge	\$107.00



IT1.C791.AN

IT2.CXXX.AN	44", 4" Drawer, LH Door, (3) 4" Drawer, 8" Drawer,	\$3,112.00
IT2.RXXX.AN	44", 4" Drawer, LH Door, (3) 4" Drawer, 8" Drawer,	\$3,342.00
	Thermofoil Metallic upcharge	\$107.00



IT2.C804.AN

IT3.CXXX.AN	44", (3) 4" Drawer, 8" Drawer, RH Door	\$2,790.00
IT3.RXXX.AN	44", (3) 4" Drawer, 8" Drawer, RH Door	\$2,981.00
	Thermofoil Metallic upcharge	\$107.00



IT3.C807.AN

IT4.CXXX.AN	44", LH Door, (3) 4" Drawer, 8" Drawer	\$2,790.00
IT4.RXXX.AN	44", LH Door, (3) 4" Drawer, 8" Drawer	\$2,981.00
	Thermofoil Metallic upcharge	\$107.00



IT4.C806.AN

Synthesis® Fixed-Height Island Tables

Available in both Cove (C) and Renew (R) door styles.

Select your cabinet color finishes on page 124.

Custom configurations are available upon request. Please contact your Midmark Portfolio Manager for more information on the right configuration for your hospital.

IT 7 . C 791 . A N

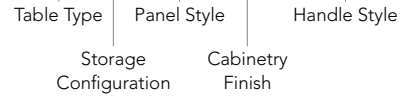

IT5.CXXX.AN	44", (3) 4" Drawer, 8" Drawer, (3) 4" Drawer, 8" Drawer	\$3,916.00
IT5.RXXX.AN	44", (3) 4" Drawer, 8" Drawer, (3) 4" Drawer, 8" Drawer	\$4,240.00
	Thermofoil Metallic upcharge	\$107.00



IT5.R312.AN

IT6.CXXX.AN	59", (3) 4" Drawer, 8" Drawer, LH Door w/Trash Drop, 4" Drawer, RH Door	\$3,571.00
IT6.RXXX.AN	59", (3) 4" Drawer, 8" Drawer, LH Door w/Trash Drop, 4" Drawer, RH Door	\$3,777.00
	Thermofoil Metallic upcharge	\$120.00



IT6.C791.AN

IT7.CXXX.AN	59", LH Door w/Trash Drop, (3) 4" Drawer, 8" Drawer, RH Door	\$3,371.00
IT7.RXXX.AN	59", LH Door w/Trash Drop, (3) 4" Drawer, 8" Drawer, RH Door	\$3,555.00
	Thermofoil Metallic upcharge	\$120.00



IT7.C807.AN

IT8.CXXX.AN	59", (3) 4" Drawer, 8" Drawer, (3) 4" Drawer, 8" Drawer, RH Door w/Trash Drop	\$4,400.00
IT8.RXXX.AN	59", (3) 4" Drawer, 8" Drawer, (3) 4" Drawer, 8" Drawer, RH Door w/Trash Drop	\$4,706.00
	Thermofoil Metallic upcharge	\$120.00



IT8.C804.AN

NOTE: For ordering information or to ask about part number items shown above, contact us at **1.844.856.1236**.

[Back to Contents](#)

Synthesis® Fixed-Height Wet Tables

Available in both Cove (C) and Renew (R) door styles.

Select your cabinet color finishes on page 124.

Wet Tables feature an open-end design simplifying plumbing integration (closed-end option available).

Open-end design is standard. Closed-end option is available.

Tub Depths: D = Deep 5" S = Shallow 3"

Custom configurations are available upon request. Please contact your Midmark Portfolio Manager for more information on the right configuration for your hospital.

WT 12 . C 791 . A D

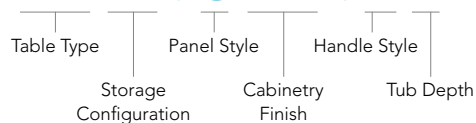

WT12.CXXX.AD 48", With 18" Overhang, With Faucet + Sprayer, RH Door, (4) 4" Drawer \$4,402.00

WT12.RXXX.AD 48", With 18" Overhang, With Faucet + Sprayer, RH Door, (4) 4" Drawer \$4,534.00

Thermofoil Metallic upcharge \$146.00

WT12.CXXX.AS 48", With 18" Overhang, With Faucet + Sprayer, RH Door, (3) 4" Drawer, 8" Drawer \$4,582.00

WT12.RXXX.AS 48", With 18" Overhang, With Faucet + Sprayer, RH Door, (3) 4" Drawer, 8" Drawer \$4,717.00

Thermofoil Metallic upcharge \$119.00



Shown with 3" Shallow Tub

WT12.R312.AS

WT22.Cxxx.AD 48", LH With 18" Overhang, With Faucet + Sprayer, LH Door, (4) 4" Drawer \$4,402.00

WT22.Rxxx.AD 48", LH With 18" Overhang, With Faucet + Sprayer, LH Door, (4) 4" Drawer \$4,534.00

Thermofoil Metallic upcharge \$146.00

WT22.Cxxx.AS 48", LH With 18" Overhang, With Faucet + Sprayer, LH Door, (3) 4" Drawer, 8" Drawer \$4,582.00

WT22.Rxxx.AS 48", LH With 18" Overhang, With Faucet + Sprayer, LH Door, (3) 4" Drawer, 8" Drawer \$4,717.00

Thermofoil Metallic upcharge \$119.00



WT22.C807.AD

Synthesis® Fixed-Height Wet Tables

Available in both Cove (C) and Renew (R) door styles.

Select your cabinet color finishes on page 124.

Wet Tables feature an open-end design simplifying plumbing integration (closed-end option available).

Open-end design is standard. Closed-end option is available.

Tub Depths: D = Deep 5" S = Shallow 3"

Custom configurations are available upon request. Please contact your Midmark Portfolio Manager for more information on the right configuration for your hospital.

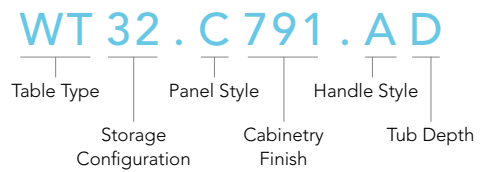

WT32.CXXX.AD	48", RH With 18" Overhang, With Faucet + Sprayer, RH Door, (2) 4" Drawer, 8" Drawer	\$4,115.00
WT32.RXXX.AD	48", RH With 18" Overhang, With Faucet + Sprayer, RH Door, (2) 4" Drawer, 8" Drawer	\$4,225.00
	Thermofoil Metallic upcharge	\$146.00
WT32.CXXX.AS	48", RH With 18" Overhang, With Faucet + Sprayer, RH Door, 4" Drawer, (2) 8" Drawer	\$4,295.00
WT32.RXXX.AS	48", RH With 18" Overhang, With Faucet + Sprayer, RH Door, 4" Drawer, (2) 8" Drawer	\$4,408.00
	Thermofoil Metallic upcharge	\$119.00



WT32.C804.AD

WT42.CXXX.AD	48", LH With 18" Overhang, With Faucet + Sprayer, LH Door, (2) 4" Drawer, 8" Drawer	\$4,115.00
WT42.RXXX.AD	48", LH With 18" Overhang, With Faucet + Sprayer, LH Door, (2) 4" Drawer, 8" Drawer	\$4,225.00
	Thermofoil Metallic upcharge	\$146.00
WT42.CXXX.AS	48", LH With 18" Overhang, With Faucet + Sprayer, LH Door, 4" Drawer, (2) 8" Drawer	\$4,295.00
WT42.RXXX.AS	48", LH With 18" Overhang, With Faucet + Sprayer, LH Door, 4" Drawer, (2) 8" Drawer	\$4,408.00
	Thermofoil Metallic upcharge	\$119.00



WT42.C791.AD

NOTE: For ordering information or to ask about part number items shown above, contact us at **1.844.856.1236**.

[Back to Contents](#)

Synthesis® Fixed-Height Wet Tables

Available in both Cove (C) and Renew (R) door styles.

Select your cabinet color finishes on page 124.

Wet Tables feature an open-end design simplifying plumbing integration (closed-end option available).

Open-end design is standard. Closed-end option is available.

Tub Depths: D = Deep 5" S = Shallow 3"

Custom configurations are available upon request. Please contact your Midmark Portfolio Manager for more information on the right configuration for your hospital.

WT 52 . C 791 . A D

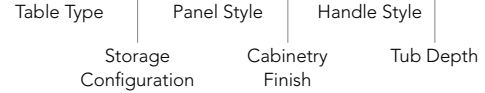

WT52.CXXX.AD 60", With 18" Overhang, With Faucet + Sprayer, RH Door, (4) 4" Drawer \$4,827.00

WT52.RXXX.AD 60", With 18" Overhang, With Faucet + Sprayer, RH Door, (4) 4" Drawer \$5,021.00

Thermofoil Metallic upcharge \$148.00

WT52.CXXX.AS 60", With 18" Overhang, With Faucet + Sprayer, RH Door, (3) 4" Drawer, 8" Drawer \$4,846.00

WT52.RXXX.AS 60", With 18" Overhang, With Faucet + Sprayer, RH Door, (3) 4" Drawer, 8" Drawer \$5,037.00

Thermofoil Metallic upcharge \$122.00



WT52.R312.AD

WT62.Cxxx.AD 60", LH With 18" Overhang, With Faucet + Sprayer, LH Door, (4) 4" Drawer \$4,827.00

WT62.Rxxx.AD 60", LH With 18" Overhang, With Faucet + Sprayer, LH Door, (4) 4" Drawer \$5,021.00

Thermofoil Metallic upcharge \$148.00

WT62.Cxxx.AS 60", LH With 18" Overhang, With Faucet + Sprayer, LH Door, (3) 4" Drawer, 8" Drawer \$4,846.00

WT62.Rxxx.AS 60", LH With 18" Overhang, With Faucet + Sprayer, LH Door, (3) 4" Drawer, 8" Drawer \$5,037.00

Thermofoil Metallic upcharge \$122.00



Shown with 3" Shallow Tub

WT62.C807.AS

Synthesis® Fixed-Height Wet Tables

Available in both Cove (C) and Renew (R) door styles.

Select your cabinet color finishes on page 124.

Wet Tables feature an open-end design simplifying plumbing integration (closed-end option available).

Open-end design is standard. Closed-end option is available.

Tub Depths: D = Deep 5" S = Shallow 3"

Custom configurations are available upon request. Please contact your Midmark Portfolio Manager for more information on the right configuration for your hospital.

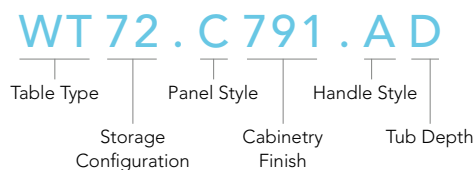

WT72.CXXX.AD	60", RH With 18" Overhang, With Faucet + Sprayer, RH Door, (2) 4" Drawer, 8" Drawer	\$4,554.00
WT72.RXXX.AD	60", RH With 18" Overhang, With Faucet + Sprayer, RH Door, (2) 4" Drawer, 8" Drawer	\$4,700.00
	Thermofoil Metallic upcharge	\$148.00

NOTE: Not available in Shallow Tub Depth



WT72.C804.AD

WT82.CXXX.AD	60", LH With 18" Overhang, With Faucet + Sprayer, LH Door, (2) 4" Drawer, 8" Drawer	\$4,554.00
WT82.RXXX.AD	60", LH With 18" Overhang, With Faucet + Sprayer, LH Door, (2) 4" Drawer, 8" Drawer	\$4,700.00
	Thermofoil Metallic upcharge	\$148.00

NOTE: Not available in Shallow Tub Depth



WT82.C791.AD

Wet Table Accessories

9A583000	Stainless Steel Grate Cover – 48"	\$311.00
9A583001	Stainless Steel Grate Cover – 60"	\$349.00
016-1300-00	Gooseneck Faucet	\$441.00
014-0637-00	Spray Assembly	\$413.00

NOTE: For ordering information or to ask about part number items shown above, contact us at **1.844.856.1236**.

[Back to Contents](#)

Stainless Steel Tables

Stainless Steel Cut-Away Exam Table with 3 Drawers and 1 Door

109-7318-11	48"L, SS Top, Cut-Away Cabinet, 3 Drw, 1 Door, Right Hand	\$3,599.00
109-7318-12	48"L, SS Top, Cut-Away Cabinet, 3 Drw, 1 Door, Left Hand	\$3,599.00
109-7418-11	60"L, SS Top, Cut-Away Cabinet, 3 Drw, 1 Door, Right Hand	\$3,666.00
109-7418-12	60"L, SS Top, Cut-Away Cabinet, 3 Drw, 1 Door, Left Hand	\$3,666.00



Height: 36", Depth: 24", Length: 60" or 48"

Stainless Steel Cut-Away Exam Table with 2 Doors

109-7417-11	60"L, SS Top, Cut-Away Cabinet, 2 Door, Right Hand	\$3,072.00
109-7417-12	60"L, SS Top, Cut-Away Cabinet, 2 Door, Left Hand	\$3,072.00
109-7317-11	48"L, SS Top, Cut-Away Cabinet, 2 Doors, Right Hand	\$2,999.00
109-7317-12	48"L, SS Top, Cut-Away Cabinet, 2 Doors, Left Hand	\$2,999.00



Height: 36", Depth: 24", Length: 60" or 48"

Stainless Steel Table

- Optional 12" x 16" x 4" deep 20-gauge stainless steel drawer may be opened from either side
- Offered on legs with adjustable glide feet or on locking casters
- Treatment surface size: 22" x 44"

101-4640-90	On Legs Without Drawer	\$682.00
101-4640-95	On Legs With Drawer	\$812.00
101-4640-80	On Casters Without Drawer	\$785.00
101-4640-85	On Casters With Drawer	\$922.00



Height 36", Width: 22", Length: 44"

Stationary Wall Mount Exam Table

- Spacious 22" x 44" work surface
- Patient weight capacity: 150 lb
- 1-1/8" thick inner board for a solid, quiet working surface
- 20-gauge stainless steel top with raised anti-drip edges
- Optional 12" x 16" x 4" 20-gauge stainless steel drawer may be opened from either side

101-1640-00	Stainless Steel Top, No Drawer	\$655.00
101-1640-05	Stainless Steel Top, with Drawer	\$762.00



Shown with Optional Drawer

Stainless Steel Wet Treatment Tables

- All stainless steel wet treatment tables include full stainless steel racks and strainer assembly
- 18-gauge, 304 stainless steel
- Full-capacity removable drawers
- Medical-grade handles
- Stainless steel hinges and latches

Stainless Steel Cut-Away Wet/Prep Table with 5" Deep Tub, 3 Drawers and 1 Door

109-7328-11	48" L, 5" D SS Tub, Cut-Away Cabinet, 3 Drw, 1 Door, Right Hand	\$4,480.00
109-7328-12	48" L, 5" D SS Tub, Cut-Away Cabinet, 3 Drw, 1 Door, Left Hand	\$4,480.00
109-7428-11	60" L, 5" D Tub W/SS Cut-Away Cab, 3 Drw, 1 Door, Right Hand	\$4,567.00
109-7428-12	60" L, 5" D Tub W/SS Cut-Away Cab, 3 Drw, 1 Door, Left Hand	\$4,567.00



Stainless Steel Cut-Away Wet/Prep Table with 5" Deep Tub, 3 Drawers & 1 Door

Faucets are sold separately, see page 148 for options

Stainless Steel Cut-Away Wet/Prep Table with Choice of Tub, 2 Doors

5"/17" Split Level Tub

109-7367-11	48" L, 5/17" D, Tub W/SS Cut-Away Cab, 2 Door, Right Hand	\$4,079.00
109-7367-12	48" L, 5/17" D, Tub W/SS Cut-Away Cab, 2 Door, Left Hand	\$4,079.00
109-7467-11	60" L, 5/17" D, Tub W/SS Cut-Away Cab, 2 Door, Right Hand	\$4,190.00
109-7467-12	60" L, 5/17" D, Tub W/SS Cut-Away Cab, 2 Door, Left Hand	\$4,190.00

5" Deep Tub

109-7327-11	48" 5" D Tub W/SS Cut-away Cab, 2 door, Right Hand	\$3,924.00
109-7327-12	48" 5" D Tub W/SS Cut-away Cab, 2 door, Left Hand	\$3,924.00
109-7427-11	60" L, 5" D Tub W/SS Cut-Away Cab, 2 Door, Right Hand	\$4,028.00
109-7427-12	60" L, 5" D Tub W/SS Cut-Away Cab, 2 Door, Left Hand	\$4,028.00



Stainless Steel Cut-Away Wet/Prep Table with Choice of Tub, 2 Doors

Faucets are sold separately, see page 148 for options

NOTE: For ordering information or to ask about part number items shown above, contact us at 1.800.299.9525.

[Back to Contents](#)

Lift Tables

Midmark® CM Dry Exam Lift Table

The Midmark CM Exam Lift Table is height adjustable from the floor up to a maximum height of 44", giving it the greatest range of motion on the market. The CM Exam Lift Table has quality features designed to create greater efficiency in your practice:

- Table lowers completely to the floor and rises to 44" high
- 300 lb load capacity
- Perpendicular design supports better eye contact with clients while providing unrestricted access to both sides of the table.
- Only the tabletop moves, unlike other units where the tabletop and back move as one piece, so the scale weight display remains at eye level no matter the position of the table.
- Table can be raised or lowered from either side via a toggle switch or by using the convenient foot pedal.
- 115V AC, 60 Hz, 10 AMP
- 55-1/2"L x 25-1/2"W x 60"H

CMWO Midmark CM Dry Lift Table without Scale \$9,373.00

CMWS Midmark CM Dry Lift Table with Scale \$10,851.00



This product has limited availability outside of the US. For confirmation, please contact Midmark Customer Experience.



Midmark® CM Wet Dental/ Treatment Lift Table

The Midmark CM Wet Dental/Treatment Lift Table is an adjustable height lift table with a wet treatment tub. The table is designed to eliminate lifting to the treatment table and to allow for a variety of operator positions. The tabletop lowers to within 9.5" of the floor and rises to 44" high. The shallow wet tub is excellent for all treatment and dental procedures. The conveniently located, temperature-controlled, ultra-light 8-ft sprayer extends beyond the table length for complete coverage and easy cleaning. The removable hair trap and easy-clean drain make maintenance a breeze. Connections provide for easy installation to hot and cold water and drain. Available in both 45" and 60" tables.

- Load capacity is 300 lb
- Freestanding, requires no bolting to floor or wall, and is completely finished including the back
- Fully assembled and ready for hook-up and immediate use
- Completely sealed units ensure a remarkably quiet actuator operation and require no internal maintenance
- 115V AC, 60 Hz, 10 AMP
- 45" Model is 62" L x 30" W x 60" H
- 60" Model is 77" L x 30" W x 60" H

CMDT-45	Midmark CM Wet Table, 45" without Scale	\$13,937.00
CMDT-60	Midmark CM Wet Table, 60" without Scale	\$13,937.00
CMDT-WS-45	Midmark CM Wet Table, 45" with Scale	\$16,594.00
CMDT-WS-60	Midmark CM Wet Table, 60" with Scale	\$16,594.00
CMDT-GC-45	Grate Cover, 45"	\$341.00
CMDT-GC-60	Grate Cover, 60"	\$341.00
002-1486-00	4" Filler Grate	\$240.00

This product has limited availability outside of the US. For confirmation, please contact Midmark Customer Experience.



4" Filler Grate



Grate Cover



Note: CM Table shown with Midmark Anesthesia Mount and Midmark VMS®

NOTE: For ordering information or to ask about part number items shown above, contact us at **1.844.856.1236**.

[Back to Contents](#)

Midmark® Mobile Lift Table

- Height adjusts from 12-3/4" to 37-1/2"
- Sturdy design with heavy duty lifting mechanism and motor is able to handle large animals
- 3" heavy-duty locking casters hold the table securely in place for exams and roll easily on even or uneven floors
- Rechargeable battery power allows the table to be used without being plugged in—charging process can be interrupted to allow table use
- Built-in battery charger—just plug in to outlet to recharge. Low-battery indicator "beeps" when charging is needed. Recharge takes only 4-6 hours.
- Large Exam Surface—22"W x 50"L 20-gauge stainless steel top with anti-drip-edges. Top has 1-1/8"-thick inner board for a solid, quiet working surface.
- Patient weight capacity: 225 lb
- Available with built-in scale for weighing at the time of exam



103-0170-16	Midmark Mobile Lift Table	\$4,072.00
110-3410-08	Midmark Mobile Lift Table with Scale	\$5,591.00
203-0170-10	Side Rails with Sliding Quick-Release Restraint Cleats (2 Rails, 4 Cleats, to be sold on non-scale model only)	\$419.00
203-0170-20	Quick-release Restraint Cleats (4, to be sold on non-scale model only)	\$177.00



Quick-release Restraint Cleats (optional)



Side Rails (optional)

Stainless Steel Lift Tables

- Lifts large animals easily and quietly—powerful electric motor and dual screw-gear column. Quiet, smooth adjustment for less patient anxiety.
- Restraint system with tie-down rails and restraint cleats located on both the left and right side of the table
- Clean, safe clinic appearance—column requires no maintenance and is covered by a full 1-year warranty. Baked-on corrosion-resistant base finish
- Tables may be stopped at any position with a full 31 1/2" range of height adjustment per model
- Patient weight capacity: 225 lb
- Available with built-in scale for weighing at the time of exam
- Limited availability outside of US

Tapered Electric Lift Table

- Height adjusts: 8 1/2" to 40" without scale, 9 1/2" to 41" with scale

101-5640-01	Electric Lift Exam Table / Hand Control	\$6,023.00
101-5640-07	Electric Lift Exam Table / Foot Control	\$6,023.00
110-3210-00	Electric Lift Exam Table with Scale / Hand Control	\$7,625.00
110-3210-01	Electric Lift Exam Table with Scale / Foot Control	\$7,625.00

Fold-up Lift Table

- Height adjusts: 7 1/2" to 39" off floor
- 22"x 44" Stainless steel top

101-5640-31	Lift Table with Hand Control	\$6,877.00
101-5640-37	Lift Table with Foot Control	\$6,877.00
110-3310-10	Lift Table with Scale and Hand Control	\$8,472.00
110-3310-21	Lift Table with Scale and Foot Control	\$8,472.00



Tapered Electric Lift Table
Width: 44", Depth: 22"



Fold-up Lift Table
Width: 44", Depth: 22"



Hand Control



Foot Control

NOTE: For ordering information or to ask about part number items shown above, contact us at 1.800.299.9525.

[Back to Contents](#)

Surgery Tables

Midmark® Surgery Tables offer the versatility of either V-top or flat top with heated or non-heated work surfaces and electric or hydraulic patient positioning. The low-profile weighted base allows you to get close the work surface while either standing or sitting. The one-hand fingertip control easily adjusts side panels and table top via pneumatic cylinders to adjust your patient as needed. 20" width and available in 50" or 60" lengths.

V-Top Surgery Tables

V-Top Surgery Table with Adjustable Electric Column

- Self-contained electric column (Column is covered by full 2-year warranty)
- Height adjustable from 29 1/2" to 41 1/2"
- Electric lift column quietly and smoothly raises and lowers
- Optional heated top
- Available accessories: rail extensions to accommodate larger animals and casters for easy mobility

100-3041-21	50" With Heated Top	\$5,230.00
100-3041-01	50" Without Heated Top	\$4,461.00
100-3071-21	60" With Heated Top	\$5,604.00
100-3071-01	60" Without Heated Top	\$4,617.00

V-Top Surgery Table with Adjustable Hydraulic Column

- Self-contained hydraulic column
- Height adjustable from 33 1/2" to 39 1/2"
- Optional heated top
- Available accessories: rail extensions to accommodate larger animals and casters for easy mobility

100-4041-21	50" With Heated Top	\$5,199.00
100-4041-00	50" Without Heated Top	\$4,435.00
100-4071-21	60" With Heated Top	\$5,601.00
100-4071-00	60" Without Heated Top	\$4,581.00



This product has limited availability outside of the US. For confirmation, please contact Midmark Customer Experience.

Width: 20", Length: 50" or 60", Base: 18" x 24"



This product has limited availability outside of the US. For confirmation, please contact Midmark Customer Experience.

Width: 20", Length: 50" or 60", Base: 18" x 24"

Flat-Top Surgery Tables

Flat Top Surgery Table with Adjustable Electric Column

- Self-contained electric column requires no maintenance (Column is covered by full 2-year warranty)
- Full 12" range of height adjustment
- Optional heated top

100-3251-21	50" With Heated Top	\$4,387.00
100-3251-01	50" Without Heated Top	\$3,489.00
100-3261-21	60" With Heated Top	\$4,573.00
100-3261-01	60" Without Heated Top	\$3,675.00



This product has limited availability outside of the US. For confirmation, please contact Midmark Customer Experience.

Flat Top Surgery Table with Adjustable Hydraulic Column

- Self-contained hydraulic column requires no maintenance
- Convenient 6" up and down height adjustment
- Optional heated top

100-4251-21	50" With Heated Top	\$4,278.00
100-4251-01	50" Without Heated Top	\$3,398.00
100-4261-21	60" With Heated Top	\$4,464.00
100-4261-01	60" Without Heated Top	\$3,573.00



This product has limited availability outside of the US. For confirmation, please contact Midmark Customer Experience.

ACCESSORIES

Drip Bucket

200-3041-02	Large Drip Bucket, 13 Quart	\$134.00
200-3041-03	Small Drip Bucket, 2 Quart	\$43.00

Caster Sets

200-3041-34	Caster Set - Plate, 4 Locking For Surgery Tables (Oct 2018–Present)	\$133.00
-------------	---------------------------------------------------------------------	----------

IV Rod

200-3041-09	Iv Rod Assembly Kit For Surgery Tables	\$157.00
-------------	----------------------------------------	----------

Rail Extension Kit

200-3041-01	Rail Extension Set, w/ Cleats For 50" Surgery Tables ONLY	\$246.00
-------------	-----------------------------------------------------------	----------



NOTE: For ordering information or to ask about part number items shown above, contact us at 1.800.299.9525.

[Back to Contents](#)

Folding Exam Tables

Fold-up Wall Mount Exam Table

- 4" from wall when folded to the "up" position
- Patient weight capacity: 150 lb

101-2640-00 44" Length, Stainless Steel Top \$1,503.00

171-2940-00 38" Length, Stainless Steel Top \$1,536.00



Fold-down Table

The unique fold-down design of our wall-mounted folding exam table features a stationary stainless steel work surface perfect for charts, instruments and client education materials. Plus, a special "gas-assist" lifting mechanism makes raising and lowering the table a breeze. Midmark tables are designed to enhance your workflow and make you, your patients and clients as comfortable as possible.

- 42" L (16" folded down) x 24" W
- Patient weight capacity: 125 lb

8012-00-001 Fold Down Exam Table \$1,448.00

9A549001 Traction Mat Accessory \$166.00

Note: Optional mounting bracket (002-1692-00, \$555.00, sold separately) or additional backing structure may be required for steel stud applications.





NOTE: For ordering information or to ask about part number items shown above, contact us at **1.844.856.1236**.

[Back to Contents](#)

Tubs

Wet Prep/Treatment Tubs

- Solid 18-gauge stainless steel construction in 48" or 60" length
- Strainer basket included
- Recessed stainless steel rack system included
- Racks rest on lip inside tub for a flush work surface with no hooks hanging over to snag clothing
- Maximum support prevents sagging
- Drop-in Wet/Prep Tubs are designed for use with your existing or custom cabinetry
- Tubs on legs feature feet with pre-attached mounting plates to secure the tub easily to the floor with no need for additional sockets or straps

1) 5" Deep Cut-Away Tub

Tub on Legs

105-0420-00	60" Long	\$2,174.00
105-0320-00	48" Long	\$1,956.00

Drop-in Tub

105-1420-00	60" Long	\$1,783.00
105-1320-00	48" Long	\$1,560.00

2) 17" Deep Tub

Tub on Legs

105-0430-00	60" Long	\$2,464.00
105-0330-00	48" Long	\$2,244.00

Drop-in Tub

105-1430-00	60" Long	\$2,073.00
105-1330-00	48" Long	\$1,854.00

3) 5"/17" Split Level Cut-Away Tub

Tub on Legs

105-0460-00	60" Long	\$2,661.00
105-0360-00	48" Long	\$2,438.00

Drop-in Tub

105-1460-00	60" Long	\$2,269.00
105-1360-00	48" Long	\$2,050.00



Faucets sold separately, see page 148

ACCESSORIES

Stainless Steel Exam Top Insert

205-1423-01	Stainless Steel Exam Top Insert for 60" Tub	\$218.00
205-1323-01	Stainless Steel Exam Top Insert for 48" Tub	\$209.00

Stainless Steel Full-Length Recessed Racks with Border Wire

205-1423-06	Stainless Steel Full-Length Recessed Racks For 60" Tubs	\$223.00
205-1323-06	Stainless Steel Full-Length Recessed Racks For 48" Tubs	\$184.00



Sinks + Faucets

Surgeon's Scrub Sinks

- Durable 16-gauge stainless steel construction
- Wall mounting bracket included
- Faucet options available

Single Surgeon's Scrub Sink

Outside: 31" wide x 23 1/2" deep x 16 1/2" tall with back splash
 Inside: 28" wide x 20" deep x 10 1/2" tall

106-1133-10 Single Surgeon's Scrub Sink \$1,244.00

Double Surgeon's Scrub Sink

Outside: 43" wide x 23 1/2" deep x 16 1/2" tall with back splash
 Inside: 40" wide x 20" deep x 10 1/2" tall

106-2133-10 Double Surgeon's Scrub Sink \$1,727.00



Faucets

Infrared Faucet & Mixing Valve

107-5292-02 Infrared Faucet and Thermostatic Mixing Valve \$1,269.00



Gooseneck Faucet

107-4292-00 Gooseneck Faucet \$212.00

Valves

1) Double Pedal Valve

107-3292-00 Double Pedal Valve \$635.00

2) Knee Action Faucet Valve

107-2292-00 Knee Action Faucet Valve \$1,562.00

3) Foot Action Faucet Valve

107-3392-00 Foot Action Faucet Valve \$495.00



NOTE: For ordering information or to ask about part number items shown above, contact us at 1.800.299.9525.

[Back to Contents](#)

Faucets

Faucets mount on standard 8" centers.

Single Lever Faucet with 84" Sprayer Hose

- 107-0112-00 Single Lever Faucet and 84" Sprayer Hose \$335.00
- 107-9093-06 Replacement 84" Hose \$74.00



Gooseneck Swivel Sink Faucet, Deck Mounted with 84" Sprayer Hose

- 107-4112-01 Gooseneck Swivel Sink Faucet, Deck Mounted with 84" Sprayer Hose \$532.00



Gooseneck Faucet with Heavy Duty Angled Sprayer

- 107-4112-02 Gooseneck Faucet, Heavy-Duty Angled Sprayer \$773.00



Spray Unit with 72" Hose and Sprayer

- 107-7212-01 Deck Mounted with Straight Sprayer \$1,021.00
- 107-7212-02 Deck Mounted with Angled Sprayer \$1,103.00

Spray Unit with Faucet and 72" Hose and Sprayer

- 107-1112-02 Deck Mounted Faucet and Straight Sprayer \$1,194.00
- 107-1112-03 Deck Mounted Faucet and Angled Sprayer \$1,285.00



Without Faucet



With Faucet

Swing Nozzle Faucet with Swivel Sprayer Unit

- Durable, heavy bronze wall construction with polished chrome finish (internal parts are replaceable)
- Built-in check valves prevent internal cross-flow of water
- Faucet and spray unit may be used simultaneously
- Spray unit may be held in the "on" position with a handle control ring included with each sprayer
- Faucet mounts on standard 8" centers
- Includes wall-mount hook for hanging the sprayer when not in use
- Sprayer features extra-long 72" flexible stainless steel hose to easily reach the entire length of the tub
- Swing nozzle faucet swivels for normal faucet applications
- Sprayer available with straight or angled sprayer

107-1112-10 Deck Mount, Straight Sprayer \$1,420.00

107-1112-11 Deck Mount, Angled Sprayer \$1,420.00



Spray Unit with 72" Stainless Steel Hose

- Attaches to standard 1/2" IPS pipe thread
- Spray unit may be held in the "on" position with handle control ring that is included with each sprayer
- Spray unit has squeeze handle valve that automatically stops water flow when not depressed
- Available with straight or angled sprayer

107-9091-02 Straight Sprayer \$398.00

107-9091-03 Angled Sprayer \$438.00



Grooming Tubs

Adjustable Height Grooming Tub with Backsplash

- 18-gauge, 304 stainless steel
- Back deck provides a convenient place to store supplies
- Strainer basket included
- Tie down rail included
- Adjustable legs allow 31-1/2" to 34-1/2" deck height
- Non-skid ramp surface
- Easy one-handed operation
- Ramp locks in upright position with a watertight seal

Adjustable Height Grooming Tub With Backsplash

105-0446-11	60" L Grooming Tub With Backsplash & Ramp On Right	\$4,135.00
105-0446-12	60" L Grooming Tub With Backsplash & Ramp On Left	\$4,135.00
105-0346-11	48" L Grooming Tub With Backsplash & Ramp On Right	\$3,821.00
105-0346-12	48" L Grooming Tub With Backsplash & Ramp On Left	\$3,821.00
105-0446-06	60" Standard Grooming Tub with Backsplash	\$3,021.00
105-0346-06	48" Standard Grooming Tub with Backsplash	\$2,886.00

ACCESSORIES

205-0446-01	Plastisol™ Coated Floor, 60"	\$424.00
205-0346-01	Plastisol™ Coated Floor, 48"	\$323.00
205-0446-00	Stainless Steel Small Animal Rack (18.5" x 22")	\$314.00



Faucets and accessories shown sold separately, see page 148. Product does not include caulk hole covers (next to faucets and accessories shown sold separately.)



Stainless Steel Rack

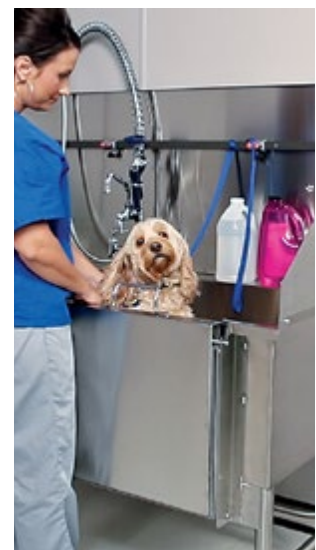

Ultralift Pro Version Elevating Grooming Tub

Unit includes single-lever faucet with hose and spray, stainless-steel restraint hoops, small dog tray raised platform, false floor raised platform and TubSitter with 60" belly band.

- 250 lb lift capacity
- Quiet and smooth electric lift system
- Inside dimension 22" x 47" to 25" x 53" top of tub
- Outside dimension 32" x 59"
- Oil-impregnated bronze bushings (self-lubricating)
- Powder-Coated steel tube frame
- Hand-laid heavy-duty fiberglass tub & surround
- 14" door height at lowest
- Elevates from 24" to 42" at ledge/rail height
- Air-operated push button controls (up/down)
- Adjustable levelers
- Removable door
- Available in white



10010787-337	59" Ultralift Pro Elevating Grooming Tub, White	\$10,404.00
10010788-337	45" Ultralift Pro, Elevating Grooming Tub, White	\$10,352.00



NOTE: For ordering information or to ask about part number items shown above, contact us at 1.800.543.5567.

[Back to Contents](#)

Midmark Limited Warranty

SCOPE OF WARRANTY

Midmark Corporation ("Midmark") warrants to the original retail purchaser that it will repair or replace components of the animal health products manufactured by Midmark (except for products and components not warranted under "Exclusions") that are defective in material or workmanship under normal use and service. The sole remedy under this limited warranty is the repair or replacement, at Midmark's option, of the applicable products or components. This limited warranty shall only apply to defects that: (i) are reported to Midmark within the applicable warranty period; and (ii) are determined to exist upon examination by Midmark. This limited warranty extends only to the original retail purchaser of a product, and is not transferable or assignable.

APPLICABLE WARRANTY PERIOD

The applicable warranty period for each Midmark product commences on the date of delivery to the original retail purchaser of the product and shall continue for the period specified in the attached Warranty Guide, which Warranty Guide is expressly incorporated herein. References in the Warranty Guide to specific component warranty periods are in place of and supersede the generally applicable warranty period for the product under which the component is listed.

OBTAINING WARRANTY SERVICE

Warranty service must be obtained through either Midmark or an authorized dealer in the Midmark product line for which warranty service is requested. Midmark may be contacted for warranty service inquiries or issues via email at www.midmark.com, by mail to Midmark Corporation, 60 Vista Drive, Versailles, Ohio 45380, or by phone at: 1-800-MIDMARK.

It is the retail purchaser's obligation to arrange for delivery of a product to Midmark or one of its authorized dealers for warranty service, which delivery shall be at retail purchaser's expense. It is also the retail purchaser's obligation to comply with the warranty service instructions provided either by Midmark or its authorized dealer. The retail purchaser must provide Midmark with completed warranty registration information within thirty (30) days after purchase in order to obtain the benefits of this limited warranty.

EXCLUSIONS

This warranty does not cover sinks, faucets and plumbing accessories. Any warranties on these items are extended directly by the manufacturer of these items to the original purchaser. Information on these manufacturers' warranties will be enclosed with the applicable products. Also, Midmark will furnish copies of any warranties extended by any such manufacturers upon request.

This warranty does not cover and Midmark shall not be liable for: (1) repairs and replacements required because of misuse, abuse, negligence, alteration, accident, freight damage or tampering; (2) matching of color, grain or texture except to commercially acceptable standards; (3) changes in color caused by natural or artificial light; (4) products which are not installed, used or properly cleaned as required in Midmark's written Installation Manual; (5) specially manufactured products; (6) products considered to be of a consumable nature such as light bulbs and surge suppression products; (7) accessories or parts not manufactured by Midmark; (8) charges by anyone (including Midmark's authorized dealers) for adjustments, repairs, replacement parts, installation or other work performed upon or in connection with such products which is not expressly authorized in writing in advance by Midmark.

EXCLUSIVE REMEDY; CONSEQUENTIAL DAMAGES DISCLAIMER

Midmark's only obligation under this limited warranty is the repair or replacement of defective parts. Midmark shall not be liable for and hereby disclaims any direct, special, indirect, incidental, exemplary or consequential damages or delays including, but not limited to, damages for loss of profits or income, loss of use, downtime, cover, and employee or independent contractor wages, payments, and benefits. This disclaimer shall survive any failure or asserted failure of the essential purpose of this limited warranty or its remedies specified herein.

NO AUTHORIZATION

No person or firm is authorized to create or approve for Midmark any other obligation or liability in connection with Midmark products.

WARRANTY DISCLAIMER

THIS LIMITED WARRANTY IS MIDMARK'S ONLY WARRANTY AND IS IN LIEU OF ALL OTHER WARRANTIES, EXPRESS OR IMPLIED. MIDMARK MAKES NO IMPLIED WARRANTIES OF ANY KIND INCLUDING ANY IMPLIED WARRANTIES OF MERCHANTABILITY OR FITNESS FOR A PARTICULAR PURPOSE.

STATUTE OF LIMITATIONS

No action may be brought against Midmark for breach of this limited warranty, an implied warranty, if any, or for any other claim arising out of or relating to the products, more than ninety (90) days following expiration of the warranty period. In the event multiple warranty periods exist with respect to a product, the ninety (90) day period provided for herein shall begin to run from expiration of the warranty period for the component to which the claim relates.

SEVERABILITY

In the event any provision of this limited warranty is determined to be invalid or otherwise unenforceable: (i) the provision shall be enforced in a manner that closest holds to its intent, while at the same time curing the invalidity or unenforceability, and (ii) the balance of this limited warranty, being severable, shall not be affected in the event the provision that is invalid or unenforceable cannot be enforced in any respect.

Products from the Midmark Carthage, MO and Leesburg, OH locations are warranted for one (1) year from the date of delivery to the original purchaser only unless specified in product warranty guide. Warranty is only applicable if customer complies with all instructions and specifications furnished by Midmark relating to installation, care, and application. Customer agrees that they will not modify, misapply, or misuse product in any manner which deviates from the Midmark instructions. Any repairs, alterations, or services provided by parties other than Midmark or its authorized representatives may void warranty. The buyer is responsible for all freight charges on returned items.

Animal Health Products Warranty Guide

PRODUCT DESCRIPTION	WARRANTY PERIOD	PRODUCT DESCRIPTION	WARRANTY PERIOD
Anesthesia Machines			
1. Midmark Anesthesia Machines	5 years	3. Midmark DR Sensor	5 years
Anesthesia Machines (Parts and Accessories)		Manufacturer defect as determined by Midmark for a period of 5 years (2 years on previous model). If the sensor ceases to function due to a catastrophic event, it will be replaced at 60% off current list the first time.	
1. Midmark and other Anesthesia Accessories (Including, but not limited to, cylinder mounting blocks, induction chambers and gas supply components)	1 year	Instrument Processing	
a. Plastic, Rubber and Disposable Parts and Products (Including, but not limited to, breathing bags, breathing tubes and endotracheal tubes.)	*	1. Midmark M9 and M11 Automatic Sterilizers	1 year
Cabinetry		2. Ultrasonic Cleaners	3 years
1. Synthesis® Cabinetry	5 years	3. Data Logger	1 year
a. Plastic, Laminate and Solid Surface Countertops	1 year	Lighting	
b. Task Light Ballast	3 years	1. Midmark Procedure Lights, Exam Lights	1 year
2. All Other Midmark Cabinetry Products (Excluding tables, listed separately below)	5 years	2. LED 120 and LED 130	3 year limited
<small>If the Midmark Modular Casework products are installed by Midmark, the above referenced warranty shall also include any labor performed, which has been authorized in writing in advance by Midmark, in connection with such repair or replacement during the applicable warranty period.</small>		Monitoring	
EXCLUSIONS		1. Midmark Multiparameter Monitor	2 years
<small>This warranty does not cover sinks, faucets and plumbing accessories. Any warranties on these items are extended directly by the manufacturer of these items to the original purchaser. Information on these manufacturers' warranties will be enclosed with the applicable products. Also, Midmark will furnish copies of any of the warranties extended by any such manufacturers upon request.</small>		a. Capnostat Mainstream Probe and LoFlo Sidestream CO ₂ Module	1 year
Carts		b. Masimo Multigas Module	2 years
1. Treatment Carts	5 years	c. Batteries	1 year
2. Procedure Carts	5 years	d. Nellcor V-SAT SpO ₂ Sensors	9 months
Containment		e. Blood Pressure Cuffs, CO ₂ Sample Lines and Adapters, and ECG Cable/Wire Sets	*
1. Stainless Steel	1 year*	2. Cardell® Insight Diagnostic Monitor	2 years
2. Fiberglass	1 year*	a. Batteries and Temperature Probes	1 year
3. FRP (Fiberglass Reinforced Plastic)	1 year*	b. Nellcor V-SAT SpO ₂ Sensors	9 months
4. Aluminum	1 year*	c. Blood Pressure Cuffs	*
5. Wood	1 year*	Scales	
6. Chain link	1 year*	1. Midmark LCD Cat Scale	1 year
*Exclusions: This warranty does not include door knobs or handles for Luxury Suite products		2. Midmark Platform Scale	1 year
Dental Delivery Systems		3. Midmark Platform Scale (Manufactured prior to March 2019)	2 year limited warranty
1. Midmark Dental Delivery Systems	2 years	Seating	
a. Replacement Parts and Accessories	90 days	1. Client Chair	1 year
2. Midmark Dental Handpieces	1 year	2. Adjustable, Air Lift Stools	1 year
a. High-speed Chuck	90 days	3. Veterinarian and Assistant Stools	2 years
Exam and Treatment Tables		Scavenging	
1. CM Lift Tables	1 year	1. Midmark Central Scavenger	5 years
2. Exam, Prep and Treatment Tables	1 year	2. Midmark Wall/Post-Mount Single Scavenger	1 year
3. Surgery Table (electric column only)	2 year	Vaporizers	
4. Surgery Table (electric)	1 year	1. VIP 3000® Vaporizers	5 years
5. Surgery Table (hydraulic)	1 year	2. VXP™ Vaporizers	1 year
Fluid Warmers		3. Midmark Serviced (Used) Vaporizers	1 year
1. IV Fluid Warmer	1 year	Ventilators and Accessories	
Imaging		1. Midmark Model 3002PRO Anesthesia Ventilators	1 year
(Must be installed by a certified Midmark installer.)		2. Bellows and Housing	*
1. Midmark DC Generator	2 years	Workstations	
2. Midmark Bite-Resistant DR Sensor	5 years	1. Worksurfaces, drawer fronts and slides	5 years
Manufacturer defect as determined by Midmark for a period of 5 years (including Optimax sensors). If the sensor ceases to function due to a catastrophic event, it will be replaced at no charge the first time.		2. Electrical components (cords, controls and accessories)	1 year

* The warranty as to these products or components only applies if such products or components are defective in material or workmanship at the time of delivery to the original retail purchaser and such defects are reported to Midmark within three (3) days from the date of delivery.

This Warranty Guide is not the entire warranty. Please see the applicable Limited Warranty for all other terms, conditions, and limitations.

Midmark Product Ordering

1. ORDERING

Please include the following with your order:

- Quantity
- Part number
- Description
- Signature of person placing the order
- Approximate shipping date required
- Method of transportation
- Purchase order number

2. RETURN OF SPECIAL DESIGN AND REGULAR MERCHANDISE

Orders for equipment, cabinetry and containment/boarding of special design, construction, finish or upholstery are not subject to cancellation after your acceptance of our acknowledgement. Special design products, custom design cabinets/containment and special upholstery WILL NOT be accepted for credit.

Authorization must be obtained for the return of any item. If return is authorized, transportation charges must be prepaid. Items returned for credit are subject to a charge of 25% or more to cover inspection, reconditioning and repackaging. Anesthesia accessory returns are not accepted for rubber goods over 30 days old, rubber goods not in original, sealed package and all hoses. Goods without a Return Goods Authorization (RA) and merchandise more than 90 days old (from Midmark invoice date) are also not accepted for return.

Note: Certain items are non-refundable: Specials, Midmark Cabinetry, Containment/Boarding, Care Exchange™ Workstations, Discontinued Items or Parts, Custom or Nonstandard Colors, Service Upholstery and Service Parts if value is less than \$50.

3. FREIGHT DAMAGE

It is the consignee's responsibility to count and inspect upon receiving. Merchandise arriving with external damage should be described on Proof of Delivery, Delivery Receipt or Bill of Lading. In case of concealed damage, consignee must contact the carrier within 5 days after receipt and claims for damage instituted.

4. IMPROVE PRODUCT QUALITY

Midmark Corporation reserves the right to change design and construction without notice.

5. ORDER CHANGES

Any requested change to an order after the acknowledged ship date could result in an extension of the scheduled ship date. The new ship date will be re-scheduled/acknowledged based on the extent of the changes requested.

6. CONTAINMENT + CABINERY ORDER CHANGES

All changes should happen before the receipt of the order. Order changes made after receipt of an order may incur a change fee and a shipping date change. This fee will cover materials, labor, and handling costs. All changes must be submitted in writing. Upon review and approval of changes, the order will be moved to the next available ship date.

Request to reschedule or delay shipment of orders that have been built will incur storage and handling fees until shipped.

7. SPECIAL ORDER REQUIREMENTS

Any order requiring special deviation from standard product will carry the following disclaimer:

We hereby accept and acknowledge the above captioned order provided, however, because of the special nature of this order in that this equipment is being supplied upon special design specifications, special materials, and/or field modification, as per your request, the standard warranties of Midmark on its products are not applicable to the order, and this acceptance and acknowledgement is conditioned upon your indemnification and promise to hold Midmark, its officers, employees and agents, harmless in respect to any and all warranty claims, damages, both direct and consequential, expenses, costs, and any liability arising from the use of or relating to this special equipment.

8. VAPORIZER SERVICE POLICY

Midmark offers service on Midmark vaporizers. Products returned for service require a return authorization (RA). Contact Customer Experience at 1.844.856.1236 to obtain an RA number. Send the product freight prepaid. A purchase order number must accompany the vaporizer.

Subsequent to servicing, each vaporizer has a separate service and performance record established which is on file in the Midmark Vaporizer Service Center in Versailles, Ohio. Should the need arise to verify that your equipment has been maintained to manufacturers specifications. We will be happy to supply this information.

9. IMAGING ORDER INFORMATION

Imaging products are not available through all Midmark authorized dealers. Please contact Midmark Animal Health Customer Experience if you need assistance locating an authorized dealer in your area.

10. ORDER CANCELLATION

Cancellation 48 hours from time of order placement is subject to penalty. An assessment will be made at the time cancellation to determine the amount of penalty including material, labor and handling costs.

Cancellations must be received in writing. Non-standard color and custom configuration orders may not be cancelled without penalty.

Orders for equipment, cabinetry and containment/boarding of special design, construction, finish or upholstery are not subject to cancellation after your acceptance of our acknowledgement. Special design products, custom design cabinets/containment and special upholstery WILL NOT be accepted for credit.

11. SHIPPING

Please call your Project Coordinator for shipping quotes at 1.800.MIDMARK.

Standard lead times may vary from typical order time frame.

Request to reschedule or delay shipment of orders that have been built will incur storage and handling fees until shipped.

12. CUSTOM ORDERS QUOTED OUTSIDE OF DESIGN SERVICE

Custom orders created outside of Design Service follow this sequence:

1. Product Quoted
2. Order placed by PO or down-payment
3. Product design created
4. Sign-offs
5. Release to production

13. CUSTOM ORDER CHANGES

All changes should happen before the release of the order. Order changes made after release of an order may incur a change fee and a shipping date change. This fee will cover materials, labor and handling costs.

Midmark Locations

Domestic Locations

BUFFALO GROVE

(formerly Lincolnshire)
1001 Asbury Drive
Buffalo Grove, IL 60089
1.800.MIDMARK

CARTHAGE

1000 Civil War Road
Area 5
Carthage, MO 64836
417.358.4466

DAYTON

Suite 300
10170 Penny Lane
Miamisburg, OH 45342
937.528.7500

GLASGOW

115 G.L. Comer Rd.
Glasgow, KY 42141
270.651.7407

KANSAS CITY

511 Osage Ave.
Kansas City, KS 66105
800.444.1579

LEESBURG

260 Depot Street
PO BOX 365
Leesburg, OH 45135
1.800.MIDMARK

TAMPA

Suite 110
10010 N. Dale Mabry Hwy
Tampa, FL 33618
1.866.447.4276

IRVINE

5171 California Ave
Suite 150
Irvine, CA 92617



TRAVERSE CITY

Education + Visitor Center
600 E. Front St.
Suite 106
Traverse City, MI 49684

2600 Miller Creek Rd.
Traverse City, MI 49684
877.983.7787

VERSAILLES

60 Vista Drive
Versailles, OH 45380
937.526.3662
1.800.MIDMARK

International Locations

INDIA

Midmark India Pvt. Ltd.
Art Guild House, "A" Wing,
Unit No. 15 + 16
Lower Ground Floor,

Phoenix Market City
LBS Road, Kurla (West),

Mumbai-400-070
+91 22 4915 300

ITALY

Newmed Srl.
Via Lenin 79/A - 42020

Quattro Castella (RE), Italy
+39 0522 875 166





Designing better care.®

midmark.com

Trade Name Notification
Canis Major, Matrix, VMS, VMS Plus, VMC, VME, VME2, VMR, VML, VIP 3000, VXP, Revive-A-Pet, VetPro, Cardell, UltraClave, QuickClean, Raintree, Synthesis, Soniclean, and Ultrafabrics are trademarks or registered trademarks of Midmark Corporation or its subsidiaries. Satelec, Acteon, Kevlar, Kydex, Athena Champion, Little Pro, Corian, Wilsonart, Nellcor and Meisinger are all trademarks or registered trademarks of their respective companies. Other products or services may be trademarks or registered trademarks of their respective companies.

CARB 93129.2 Phase 2 Compliant and TSCA Title VI Compliant

Midmark is an ISO 13485 and ISO 9001 Certified Company. Certain products are not included. See the complete list at: midmark.com/ISO

International Color Coding
Midmark Veterinary Anesthesia Machines are manufactured in the United States for a variety of countries according to several domestic and international gas color-coding standards. All products pictured in this catalog are of standard ANSI (USA) color coding with the appropriate part numbers of your country or ISO standard listed for your convenience. All products shipped will be manufactured according to the part number specified at the time of purchase. United States/Japan: Green, Canada: White, Standard ISO: White

© 2023 Midmark Corporation, Versailles, Ohio USA
Products subject to improvement changes without notice. Litho in USA.
007-0739-00 Rev. P4 (9/23)

