

S I M U L A T I O N  
U N I T

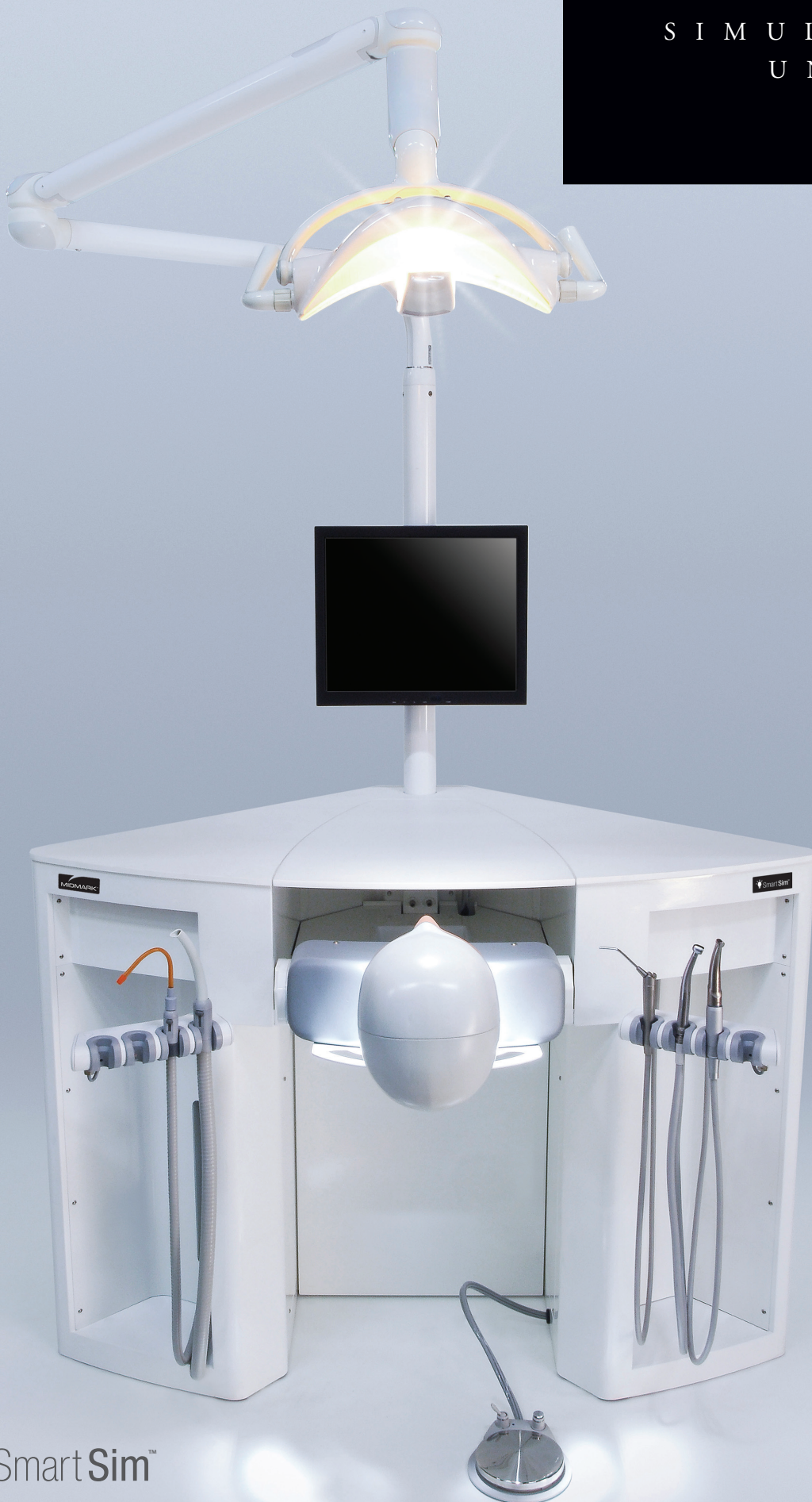

# INNOVATION IN DESIGN

Give faculty and students a competitive advantage with the ultimate teaching and collaboration tool – SmartSim™ by Midmark. With a unique triangular shape, SmartSim™ brings together functionality, digital presentation and space-savings like nothing you've ever seen before.

Specially developed for universities and dental schools, SmartSim™ features a modular structure, maximizing space through the creation of configurable, self-contained "learning islands." It's a simulation bench, multimedia station and student workspace all in one space-saving unit. Ideal for use with one person or a small group, SmartSim™ can be adapted for right-handed or left-handed users.

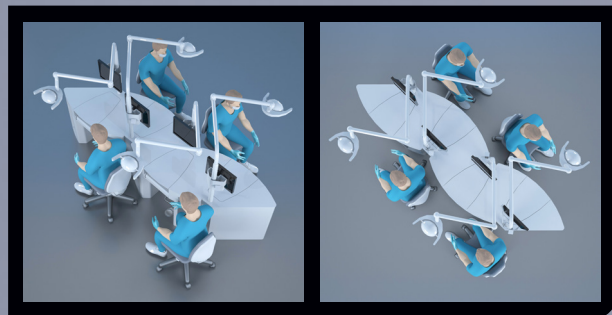

Face-to-face Configuration

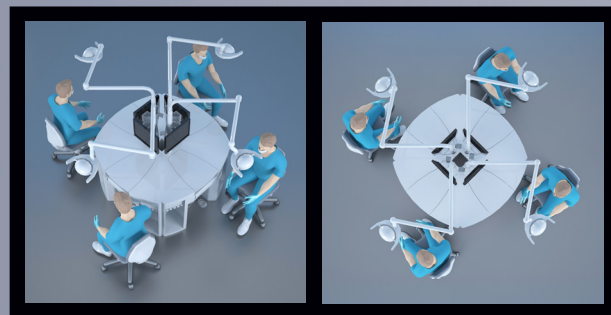

Island Configuration

## Maximize Space

A reduced footprint and modular, space-saving design gives SmartSim™ the flexibility needed to maximize classroom space. With multiple configurations available, like island or face-to-face, SmartSim™ is the perfect design solution for any facility, promoting proper ergonomics for students and improved visibility of the instructor.



FORM AND  
FUNCTION

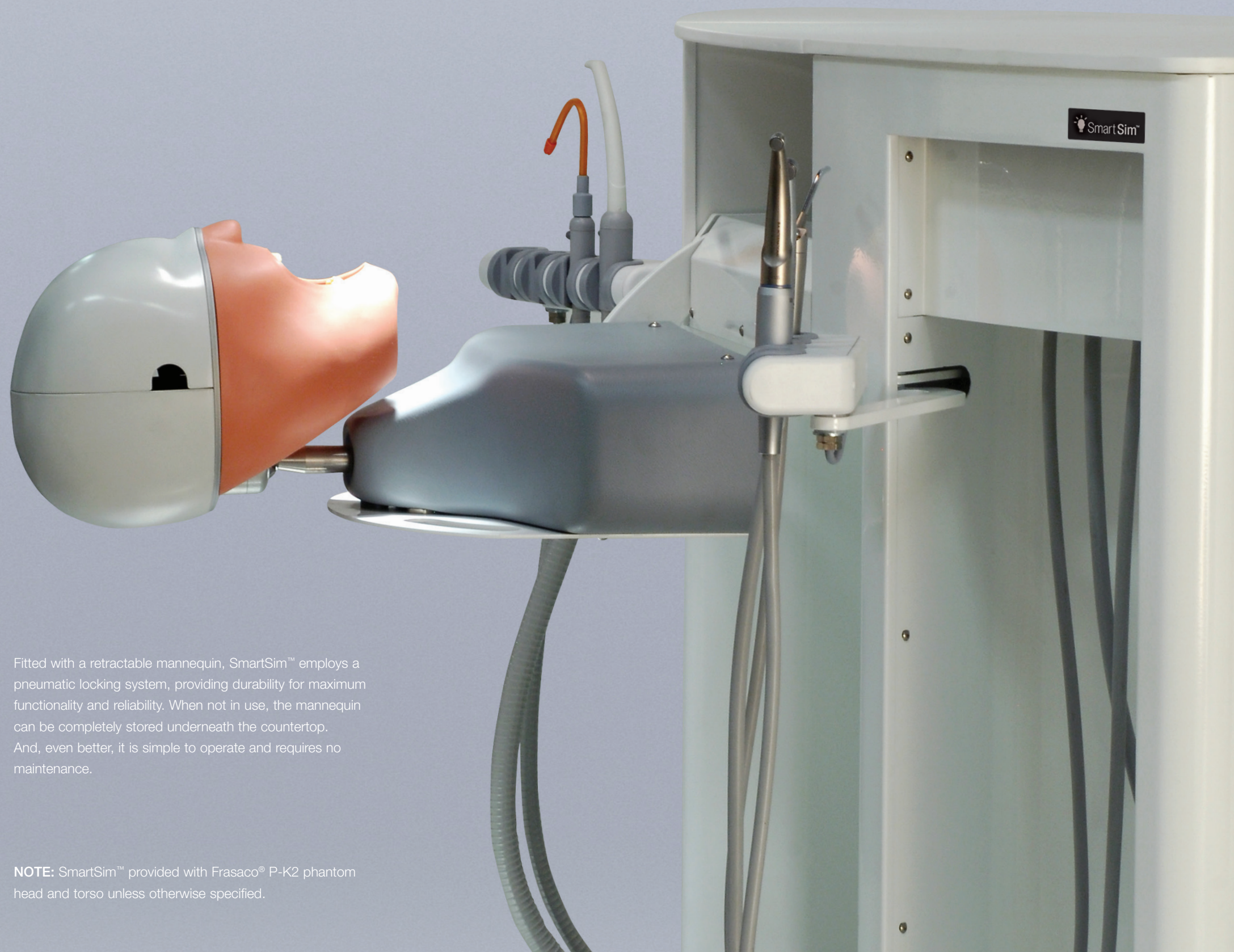

Fitted with a retractable mannequin, SmartSim™ employs a pneumatic locking system, providing durability for maximum functionality and reliability. When not in use, the mannequin can be completely stored underneath the countertop. And, even better, it is simple to operate and requires no maintenance.

**NOTE:** SmartSim™ provided with Frasco® P-K2 phantom head and torso unless otherwise specified.

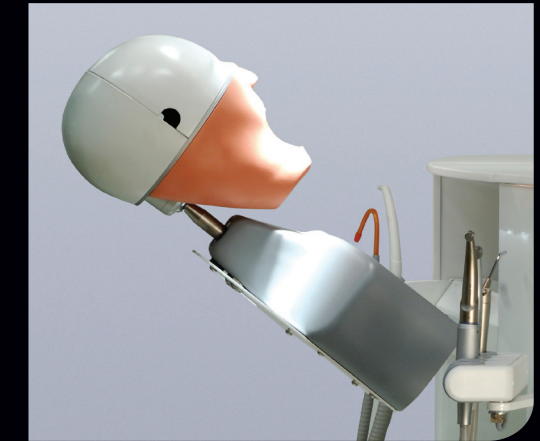

The SmartSim™ mannequin features double articulating joints. This allows for a wide range of working positions: -15 degree to 90 degrees from the central axis. Handling and repositioning of the mannequin realistically recreates patient positioning for users.



P E R F E C T  
S I M U L A T I O N

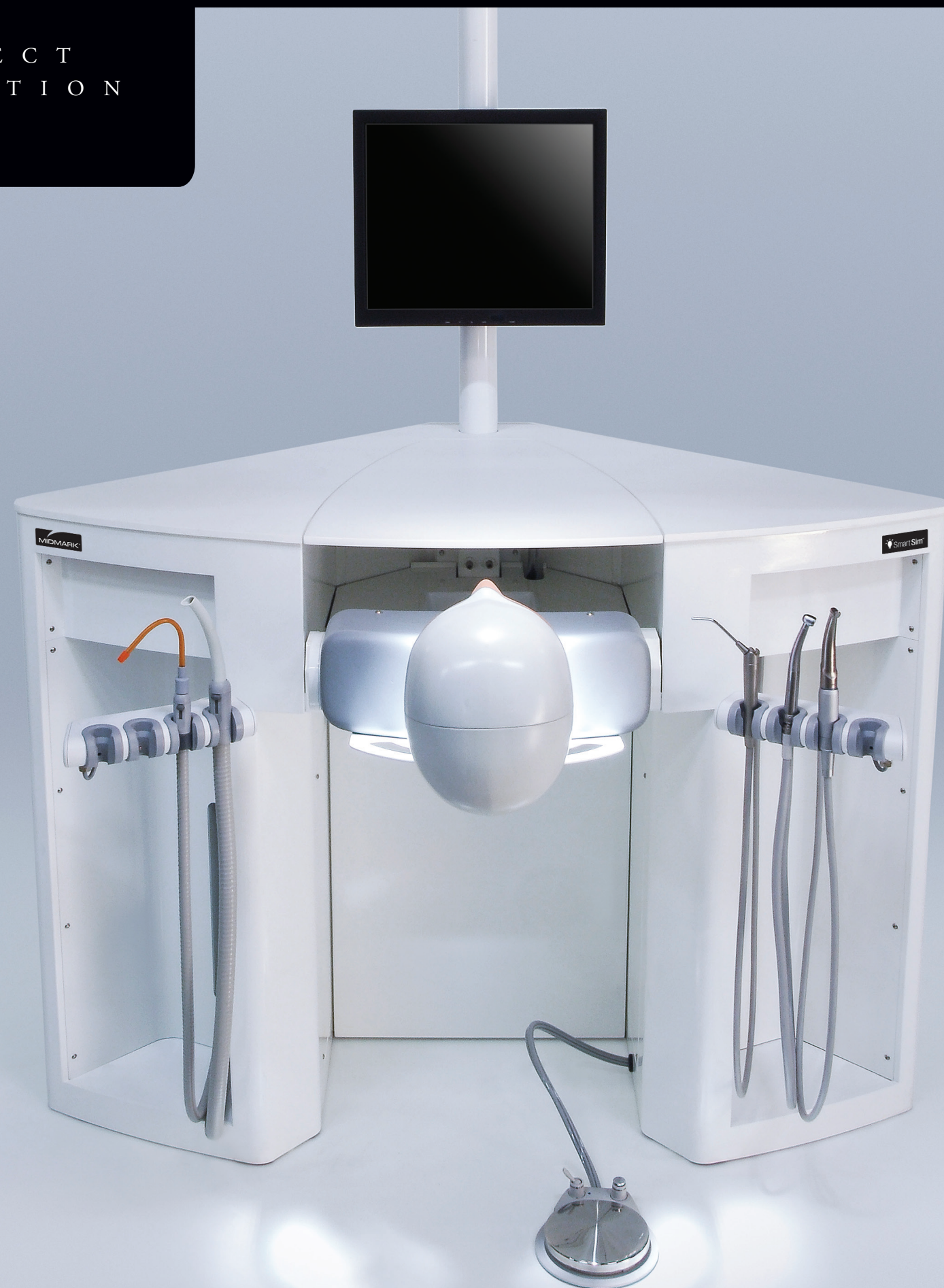

Equipped with both doctor's and assistant's instrumentation, SmartSim™ provides instruments typically used in dental practices all within easy reach – ideal for four-handed simulation.

Included Standard Model Features:

- Triangular cabinet steel structure
- Doctor's side: 4-position instrument holder with 1 low speed HP, 1 high speed HP and syringe
- Assistant's side: 4-position instrument holder with HVE and saliva ejector
- Automatic handpiece selection on both doctor's and assistant's holder
- Foot control
- Hi-Macs® solid surface worktop
- Phantom head & torso storage compartment
- Operating LED light and light pole

S I M P L I F I E D



SmartSim™ is also available in a base model configuration with an instrument holder on the doctor's side – ideal for two-handed simulation. The other side is equipped with two open shelves for storage and is available with optional doors that lock.

Included Base Model Features:

- Triangular cabinet steel structure
- Doctor's side: 4-position instrument holder with 1 low speed HP and syringe
- Assistant's side: Saliva ejector and two shelf storage compartment
- Manual selection of handpieces (unless optional fiber optics is chosen)
- Foot control
- Hi-Macs® solid surface worktop
- Phantom head & torso storage compartment
- Operating LED light and light pole

DELIVERY OPTIONS	STANDARD MODEL	BASE MODEL
Fiber optic upgrade	•	•
Brushless electric motor upgrade with fiber optics	•	•
Brushless electric motor upgrade with fiber optics & endo function	•	•
Upgrade right hand/left hand convertible	•	
2nd HP connection for base model		•

CABINET OPTIONS/ACCESSORIES	STANDARD MODEL	BASE MODEL
Instrument tray	•	•
Built-in venturi system with collector tank	•	•
Built-in water supply with pressurized bottle	•	•
15" 4-Drawer cabinet (for extra storage & CT space)	•	•
Single door (or two smaller doors) for storage side on base model		•
Double power outlet	•	•

ET3G SOFTWARE & MULTIMEDIA OPTIONS	STANDARD MODEL	BASE MODEL
Full HD Video camera support arm	•	•
Full HD video camera	•	•
Student PC	•	•
Server unit (server unit + HD board)	•	•
Full HD 16:9 PC monitor	•	•
Monitor & PC support bracket (fixed on light pole)	•	•
Switch 1 GB 5 port ethernet	•	•
Switch 1 GB 16 port ethernet	•	•
Switch 1 GB 24 port ethernet	•	•
Cabinet for server unit complete w/ solid surface top & fans	•	•

FRASACO® OPTIONS	STANDARD MODEL	BASE MODEL
Frasaco® phantom PK-2 with torso and 1 AG-3 dental model	•	•
Frasaco® phantom P 6-3 with torso and 1 AG-3 dental model	•	•
Frasaco® Dental Model AG-3	•	•
Frasaco® Face Mask P6-GM	•	•
Frasaco® Elastic Tongue P6-Z	•	•
Eyes for phantom heads (stickers)	•	•
Ears for phantom heads	•	•
1260M set of magnetic model mounting plates	•	•

## D I M E N S I O N S

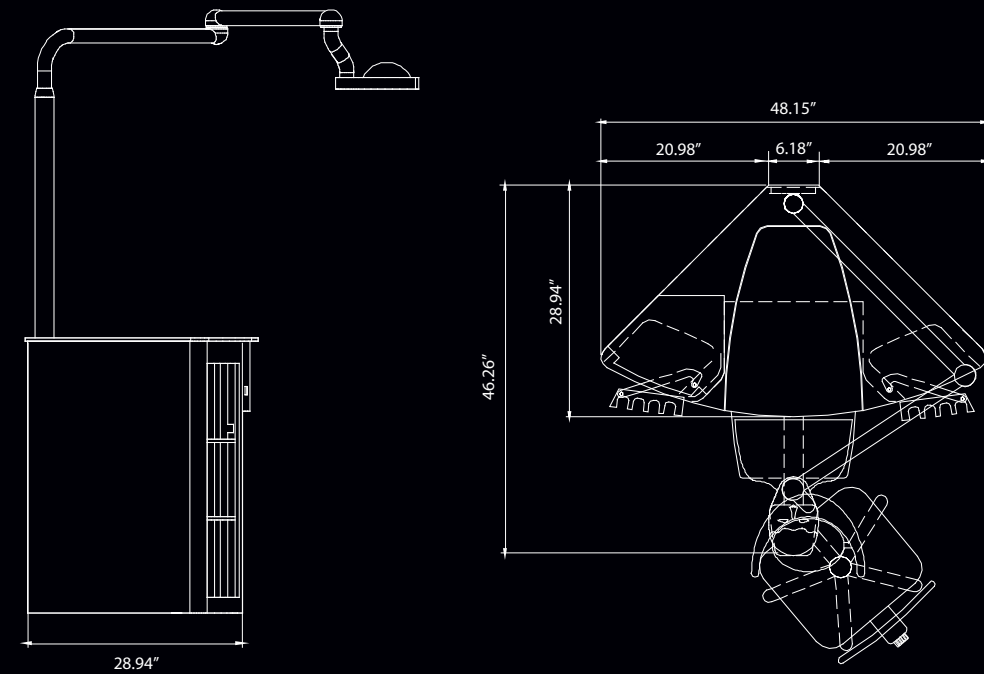
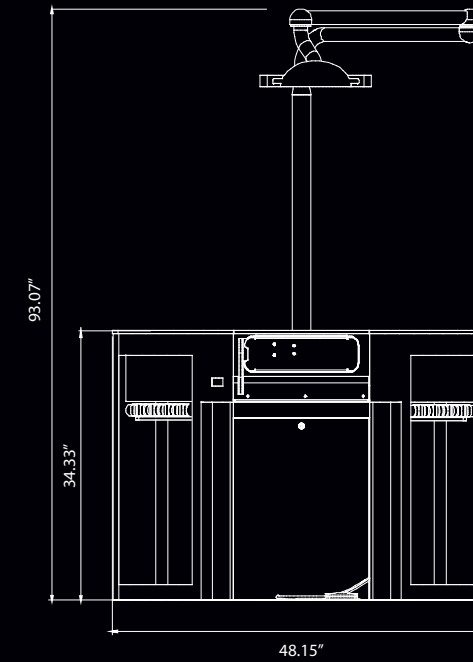

Product is intended for teaching purposes only and not for use on humans.

**Midmark is an ISO 13485 and ISO 9001 Certified Company.**  
For more information or a demonstration, contact your Midmark  
dealer or call: 1-800-MIDMARK Fax: 1-877-725-6495  
Outside the U.S.A. call: 1-937-526-3662 Fax: 1-937-526-8214  
or visit our website at [midmark.com](http://midmark.com)

© 2011 Midmark Corporation  
60 Vista Drive, Versailles, Ohio 45380  
Products subject to improvement changes without notice  
Litho in U.S.A. 007-0906-00 Rev. C1 (3/16)

