

VF-100

Portable Syringe Pump

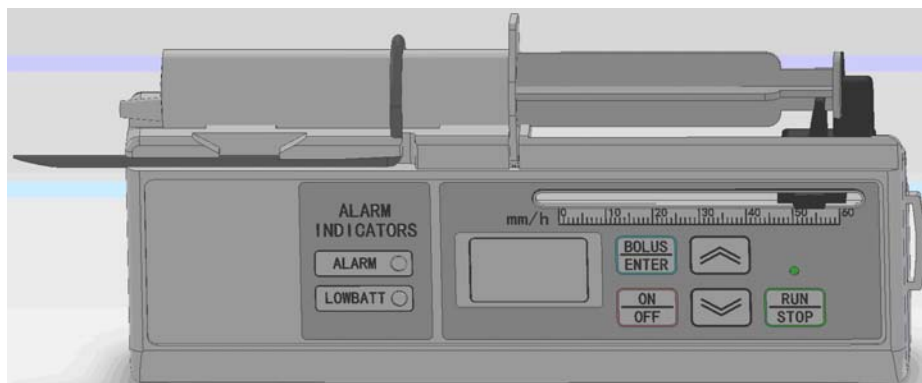

Operation Manual



Midmark Corporation
60 Vista Drive, P.O. Box 286
Versailles, Ohio 45380-0286
1-800-MIDMARK
www.midmark.com

TABLE OF CONTENTS

GENERAL INFORMATION	3
PRODUCT FEATURES	4
FIGURES AND SIGNS	5
PRECAUTIONS & NOTES	5
PREPARING FOR THE INFUSION.....	8
STARTING AN INFUSION	8
ALARMS AND INDICATION	11
OCCLUSION.....	11
COMPLETED.....	11
LOW BATTERY	12
NEAR EMPTY.....	12
MECHANISM ERROR.....	12
SYRINGE DISENGAGED.....	13
SYRINGE NOT INSTALLED.....	13
KEYPAD DESCRIPTION	13
KEYPAD FUNCTIONS	15
PROGRAMMING THE SETTINGS.....	15
TROUBLESHOOTING	18
SPECIFICATIONS.....	19
INFUSION ACCURACY OF THE SYSTEM	20
REGULATORY INFORMATION.....	21
ACCESSORIES.....	22
PACKAGE, TRANSPORTATION AND STORAGE.....	23
MAINTENANCE.....	24
MAINTENANCE SERVICE RECORD.....	25
LIMITED WARRANTY	27

GENERAL INFORMATION

THIS PORTABLE SYRINGE PUMP IS AN EASY-TO-OPERATE DEVICE FOR INFUSION WITH 1-20ML SYRINGES. IT IS LIGHT WEIGHT AND OFTEN USED IN A MOBILE ENVIRONMENT, PROVIDING A MICRO, CONSISTENT, AND ACCURATE INFUSION. A WIDE VARIETY OF CLINICAL DEPARTMENTS, SUCH AS INTERNAL MEDICINE, CARDIOLOGY, AND ONCOLOGY REQUIRE BEING EQUIPPED WITH THIS TYPE OF SYRINGE PUMP.

BEFORE USING THE PUMP, BE SURE TO READ THIS OPERATION MANUAL CAREFULLY AND UNDERSTAND ALL SECTIONS OF THIS MANUAL. FAILURE TO READ AND UNDERSTAND THE INSTRUCTION MANUAL MAY LEAD TO MISUSE OF THE PUMP, WHICH COULD RESULT IN HARM TO THE PATIENT.

HEADINGS USED IN THIS MANUAL

THIS GUIDE CONTAINS WARNINGS, CAUTIONS, AND IMPORTANT INFORMATION TO BRING TO YOUR ATTENTION; AS WELL AS, IMPORTANT SAFETY AND OPERATIONAL ASPECTS OF THE PUMP. TO HELP IDENTIFY THESE ISSUES WHEN THEY OCCUR IN THE TEXT, THEY ARE SHOWN USING THE FOLLOWING HEADINGS:

⚠️ WARNING

STATEMENTS THAT DESCRIBE SERIOUS ADVERSE REACTIONS AND POTENTIAL SAFETY HAZARDS.

CAUTION

STATEMENTS THAT CALL ATTENTION TO INFORMATION REGARDING ANY SPECIAL CARE TO BE EXERCISED BY THE PRACTITIONER FOR THE SAFE AND EFFECTIVE USE OF THE DEVICE.

IMPORTANT

STATEMENTS THAT CALL ATTENTION TO ADDITIONAL SIGNIFICANT INFORMATION ABOUT THE DEVICE OR A PROCEDURE.

PRODUCT FEATURES









This syringe pump is a continuous micro infusion device.

Category:	Type I Internal Power Supplied
Type of Protection Against Electric Shock:	 Type BF
Degree of Protection Against Ingress of Fluids	Drip-Proof IPX1
Mode of Operation:	Continuous operation
Power Supply:	DC 3.6V --- 4.5V By AA Battery X 3
Application:	Single use syringe size: 1 ml, 3 ml, 5 ml, 10 ml, 20 ml

⚠ WARNING: Must operate this pump with Pump-Use syringes. Fail to comply will cause inaccurate infusion result and may harm the patient.

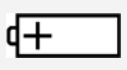
- (1) This product controls the flow rate of an injection. The rate is not affected by intravenous/artery pressure or by thickness of the fluid.
- (2) This product performs a self-diagnosis when power is turned on.
- (3) Support wide range of syringe brands. (Refer to chapter of Recommended Syringe Brands)
- (4) Infusion setting is from 1 to 99 mm/hr.
- (5) This product memorizes the last/previous infusion settings, even after the pump is power-off.
- (6) When an error occurs, pump stops immediately. No siphon happens. The volume infused is less than 0.15ml during the interval between an error occurrence and the pump stopping.

FIGURES AND SIGNS

Signs/Symbols	Definitions
	Protection Against Electric Shock: Type BF,
IPX1	Protection against vertically falling water drips
	Attention, consult operation manual
	Manufacturer's information
SN	Product Serial Number
	Manufacturing Date
	Battery Power
	Environmental Protection
LOW BATT	Low Battery LED Indicator
ALARM	Alarm LED indicator
 ON	Power Switch
 OFF	

PRECAUTIONS & NOTES

SAVE THIS MANUAL FOR YOUR FUTURE REFERENCE!

IMPORTANT: USER SHOULD READ THIS ENTIRE MANUAL BEFORE OPERATING THIS SYRINGE PUMP. THIS DEVICE SHALL BE OPERATED BY AUTHORIZED PERSONNEL. OPERATIONS OF THE DEVICE SHALL BE CONSTANTLY SUPERVISED BY AUTHORIZED PERSONNEL.

⚠ WARNINGS: CRITICAL EXPLOSION HAZARD! DO NOT USE IN THE PRESENCE OF INFLAMMABLE AND EXPLOSIVE MATERIALS!

(1) DO NOT OPERATE THIS DEVICE IN THE PRESENCE OF FLAMMABLE ANESTHETISCS (A

- MIXTURE OF AIR, OXYGEN, AND NITROGEN OXIDES.)
- (2) DO NOT USE A PUMP, SYRINGE, OR ACCESSORY THAT SHOWS ANY SIGN OF DAMAGE.
 - (3) DO NOT CONNECT THE DEVICE TO THE PATIENT, WHILE PURGING THE TUBING.
 - (4) DO NOT IMMERSE THE PUMP INTO WATER OR ANY ANOTHER LIQUID.
 - (5) BEFORE CONNECTING THE EXTENSION TUBING TO THE PATIENT, CHECK THE EXTENSION TUBING TO MAKE SURE IT IS NEATLY PLACED. MAKE SURE THERE IS NO AIR IN THE SYRINGE AND EXTENSION TUBING. THIS PUMP CAN NOT DETECT AIR-IN-LINE.
 - (6) BEFORE STARTING INFUSION CHECK ALL SETTINGS ON THE SYRINGE PUMP.
 - (7) IF THE PACKAGE OF THE SINGLE USE SYRINGE IS DAMAGED, DO NOT USE THIS SYRINGE.
 - (8) DO NOT USE THE SYRINGES THAT HAVE NOT BEEN TESTED FOR OR AUTHORIZED ON THIS SYRINGE PUMP. USE OF UNTESTED OR UNAUTHORIZED SYRINGES MAY INJURE THE PATIENT. CONTACT LOCAL DISTRIBUTOR FOR INFORMATION ON SYRINGE ACCURACY AND AUTHORIZED SYRINGE BRANDS.

PRECAUTIONS:

- (1) TO AVOID A MALFUNCTION CAUSED BY ELECTROMAGNETIC DISTURBANCE, THE PUMP SHOULD BE OPERATED AWAY FROM DEVICES SUCH AS ELECTROCOAGULATORS AND DEFIBRILLATORS WHICH MAY CREATE A STRONG ELECTROMAGNETIC FIELD. DURING OPERATION, PLEASE NOTICE THAT THE PUMP:
 - a. MUST BE KEPT AT ENOUGH DISTANCE FROM ELECTROCOAGULATORS AND/OR DEFIBRILLATORS;
 - b. DO NOT SHARE THE SAME POWER OUTLET WITH ELECTROCOAGULATORS AND/OR DEFIBRILLATORS;
 - c. OPERATE UNDER CONTINUOUS SUPERVISION;
 - d. DO NOT USE THE PUMP IN A MRI ROOM OR HIGH-PRESSURE ROOM THAT CREATES A STRONG ELECTROMAGNETIC FIELD;
 - e. DO NOT USE DEVICES WHICH MAY EMIT HIGH-FREQUENCY SIGNALS IN PLACE WHERE THE PUMP OPERATES. KEEP THE SYRINGE PUMP AWAY FROM THE MENTIONED DEVICES;
- (2) ONLY USE SYRINGES RECOMMENDED BY THE MANUFACTURER. (REFER TO CHAPTER OF RECOMMENDED SYRINGE BRANDS) ACCURACY OF AN INFUSION AND ALARMS WILL BE AFFECTED BY THE ACCURACY OF DIFFERENT SYRINGES.
- (3) MAKE SURE THE BATTERIES ARE TAKEN OUT OF THE PUMP, IF THE PUMP WILL NOT BE USED FOR A LONG PERIOD OF TIME;
- (4) AFTER MIN. 3 MONTHS OF STORAGE, CHECK THE ACCURACY OF INFUSION AND MAKE SURE THAT ALL ALARMS FUNCTION PROPERLY BEFORE USING THE PUMP.
- (5) AVOID CONNECTING TUBING OF A PUMP-CONTROLLED SYRINGE WITH TUBING OF A MANUAL-CONTROLLED SYRINGE. IT MAY AFFECT THE INFUSION ACCURACY AND ACTIVATE FALSE ALARMS. THE SYRINGE PUMP GENERATES A PRESSURE, DRIVING MEDICATION INTO THE PATIENT. BUT THE PUMP CANNOT DETECT DAMAGE CAUSED BY OVERPRESSURE, E.G. LEAKING, DISENGAGEMENT OF SYRINGE AND EXTENSION TUBING. DURING THE OPERATION, CONSTANTLY CHECK THE STATUS OF THE TUBING SYSTEM;
- (6) DISPOSABLE SYRINGES USED IN THE PUMP SHOULD COMPLY WITH THE GOVERNMENT REGULATIONS AND HAVE TO BE DESIGNED FOR PUMP-USE;

- (7) USE AND CHANGE SYRINGES AND EXTENSION TUBING ACCORDING TO HOSPITAL REGULATIONS. SINGLE USE SYRINGE AND TUBING SHALL BE STORED IN A CENTRALIZED LOCATION AFTER USE, AND BE DISPOSED OF ACCORDING TO REGULATIONS OF DISPOSAL OF MEDICAL WASTE;
- (8) THE CIRCUIT DIAGRAM AND PARTS LIST WILL ONLY BE PROVIDED TO THE TECHNICIANS ASSIGNED BY THE MANUFACTURER;
- (9) THE PUMP WILL GO THROUGH A SELF-DIAGNOSIS PROGRAM WHEN THE POWER SWITCH IS TURNED ON. IF AN "ERR" IS SHOWN IN THE DISPLAY, REBOOT THE PUMP. IF THE ERROR CONDITION STILL EXISTS, DO NOT CONTINUE THE OPERATION AND IMMEDIATELY CONTACT A DISTRIBUTOR OR THE MANUFACTURER FOR TECHNICAL SERVICE;
- (10) READ THE INSTRUCTIONS ON THE PACKAGE CAREFULLY BEFORE LOADING THE SYRINGE ONTO A PUMP. STRICTLY FOLLOW THE MEDICAL PROTOCOLS AND REGULATIONS DURING THE OPERATION;
- (11) LUER-LOCK SYRINGES SHOULD ALWAYS BE USED TO ENSURE SECURE CONNECTION OF THE EXTENSION TUBING;
- (12) DO NOT CLEAN, DISINFECT OR STERILIZE ANY PART OF THE PUMP WITH ETHYLENE OXIDE GAS OR BY AUTOCLAVING. THIS MAY DAMAGE THE PUMP AND WILL VOID THE WARRANTY; DISINFECT THE PUMP'S EXTERNAL PARTS USING APPROVED CLEANSERS OR DISINFECTANTS ONLY;
- (13) THESE CHEMICALS MAY DAMAGE THE PUMP'S FRONT PANEL INCLUDING DISPLAY: ACETALDEHYDE, ACETONE, AMMONIA, BENZENE, HYDROXYTOLUENE, METHYLENE CHLORIDE, OR OZONE. DO NOT USE CHEMICALS OR CLEANSERS CONTAINING N-ALKYLDIMETHYLBENZYLAMMONIUM CHLORIDE;
- (14) USE OF NON-RECOMMENDED ACCESSORIES MAY RESULT IN INCREASED EMC EMISSIONS OR DECREASED EMC IMMUNITY OF THIS PUMP.
- (15) WHILE USING THIS PUMP FOR INFUSION OF LIFE-SUSTAINING MEDICATION, MAKE SURE THERE IS AN EXTRA PUMP ON STANDBY, AND THERE ARE ENOUGH SYRINGES ON STANDBY.

IMPORTANT:

- (1) TO PREVENT ELECTRIC HAZARDS, TURN OFF THE PUMP AND TAKE BATTERIES OUT OF THE PUMP. BEFORE CLEANING, USE 70% ALCOHOL ON A SOFT CLOTH TO WIPE OFF ANY FLUID ON THE PUMP. KEEP THE PUMP CLEAN AND DO NOT IMMERSE THE PUMP INTO ANY LIQUID FOR CLEANSING PURPOSES;
- (2) BATTERIES USED IN THIS PUMP ARE AA X 3 (4.5V). TO ENSURE THE PERFORMANCE OF THE SYRINGE PUMP, MAKE SURE THE BATTERIES HAVE ENOUGH POWER BEFORE STARTING AN INFUSION.
- (3) ONLY AUTHORIZED SERVICE PERSONNEL SHOULD REPAIR THIS PUMP. THE MANUFACTURER ASSUMES NO RESPONSIBILITY FOR INCIDENTS IF THE PUMP IS NOT REPAIRED ACCORDING TO THE AUTHORIZED PROCEDURES;
- (4) IF THE PUMP FALLS ON THE GROUND, IT MAY BE DAMAGED INTERNALLY WITH NO EXTERNAL SIGN OF DAMAGE. IN SUCH SITUATION, THE PUMP PERFORMANCE MAY BE AFFECTED. DO NOT USE THE PUMP, AND CONTACT AUTHORIZED DISTRIBUTORS FOR SERVICE.

PREPARING FOR THE INFUSION

1. Keep the pump horizontal.
2. Prepare the disposable syringe and extension tube according to the instructions on the packages. ONLY use syringes and extension tube with a luer-lock connection. This connection guarantees that the drain will not slip off due to a rise in pressure during the infusion.
3. To ensure an accurate performance, use syringes recommended by the manufacturer or dealers. Use only pump-use syringes.

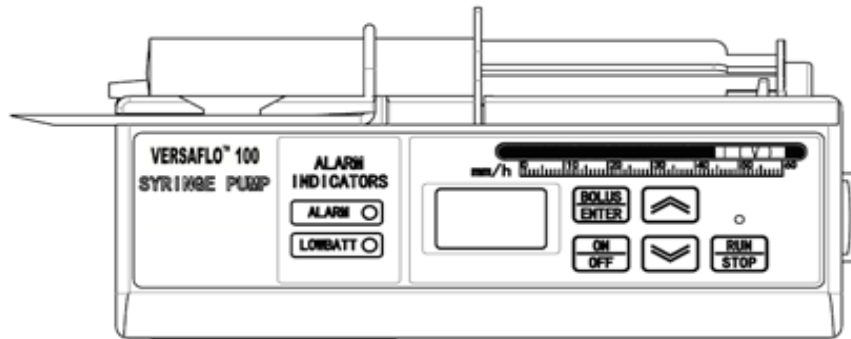

STARTING AN INFUSION

⚠ WARNING: Read this manual carefully before using the pump for the first time.

1. Open the battery cover located at the back of the pump. Insert 3 AA batteries into the battery compartment with the correct polarity as shown in the picture. Three NEW batteries may support continuous running for up to 24 hours at a flow rate of 5 mm/hr with a syringe size 10 ml.
2. When the power is turned on, the pump will go through a self-diagnostic program, to self-diagnose the major components.
3. Purge the syringe to expel the air. Load the syringe and place the extension tubing properly.
4. Be sure to insert the syringe flange firmly into the flange slot on the pump. Use securing strap to secure the syringe to the pump. These are to prevent the syringe from moving during the infusion.

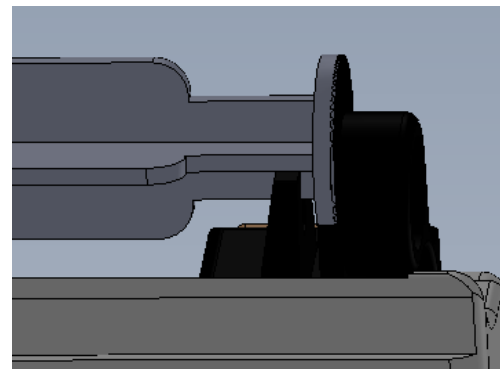
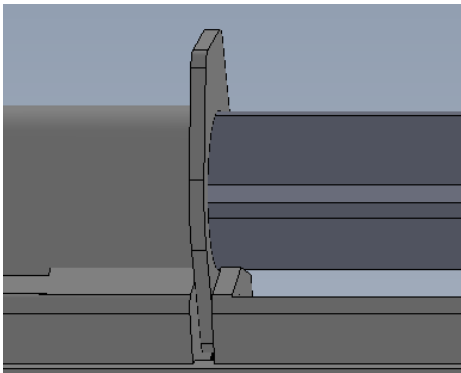
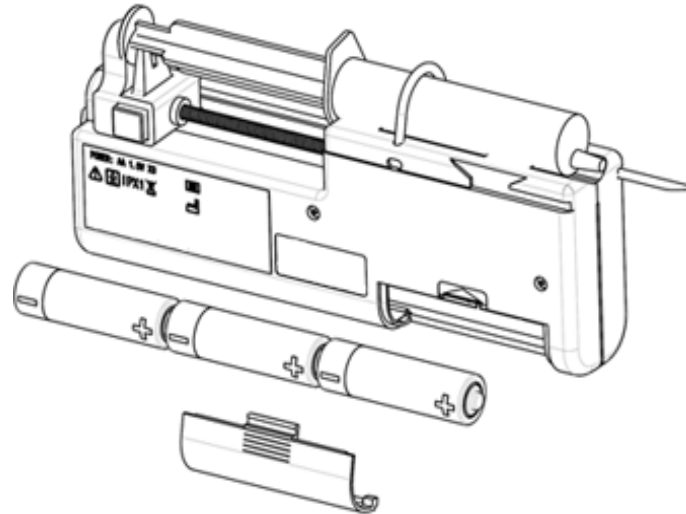

⚠ WARNINGS: A loose installation of the syringe will cause an inaccurate infusion.

5. Press the release button on the plunger holder and slide the mechanism to the right until the end of the syringe plunger placed into the slot in the plunger holder. Make sure the syringe plunger is properly seated in the plunger holder.
6. Press the power switch ON. When it is initialized, the pump will go through a Self-Diagnostic program. After the pump passes the Self-Diagnosis, previous infusion rate settings will be displayed. The pump is then ready to be programmed for an infusion.

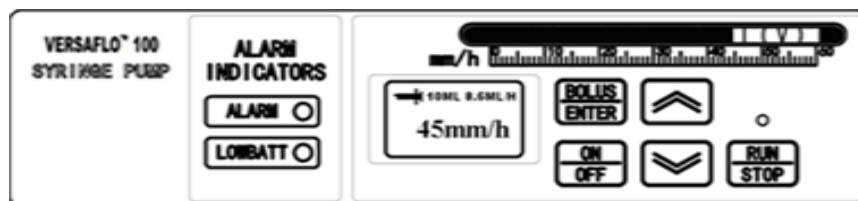

7. When the pump is not loaded with a syringe, the ALARM indicator which is a yellow LED will light, accompanied by a beeping sound with 15 seconds' interval. Not until the syringe is installed properly, will the yellow LED indicator turn off and the beeping sound turn off.
8. Press **RUN/STOP** to start infusion, then the RUN indicator which is a flashing green LED light.

9. In situations where the user wants to stop an infusion, press the  button.
10. This syringe pump is compatible with the following syringe sizes:
1ml, 3ml, 5ml, 10ml, 20ml syringe , with rate range 1-99mm/hr

Reason for the failure of the Self Diagnostic program

1. If the pump fails to initialize the Self-Diagnostic program, the screen will display 'INITIAL. ERROR SYSTEM STOP' indicating that the pump did not pass the Self-Diagnostic program. Check the following position for cause of alarm,
 - 1) In a situation that the plunger holder is placed at the very left end. Move the plunger holder to the right end where it is possible to load the syringe and reboot the pump;
 - 2) In a situation that the plunger holder is at a proper position. Stop using the pump until it is serviced by authorized personnel.

INITIAL. ERROR
SYSTEM STOP

2. If the pump fails to initialize the Self-Diagnostic program, the screen will display 'BATTERY LOW SYSTEM STOP', a change of new batteries is required immediately.

⚠️ WARNINGS: DO NOT use the pump if the BATTERY LOW alarm is ON. The pump may stop during the infusion because of low battery power.

BATTERY LOW
SYSTEM STOP

BATTERY LOW

45mm/h

ALARMS AND INDICATION

The pump has a complete alarm and indicating system. While the pump is running and the alarm is set off, the system will notify the user of the unusual parameters during the operation. The occlusion alarm may have a delayed effect. The rest of the alarms will reflect the unusual parameters immediately (less than 10 seconds). All alarms are technical alarms. There is no biological alarm.

ALARM CATEGORY AND PRIORITY LIST

Alarm Category	Priority	Alarm Indicating Method
Syringe Not Installed	Medium	With medium sound accompanied by a flashing yellow light
Occlusion	High	With high level sound accompanied by a flashing red light
Completed	High	With high level sound accompanied by a flashing red light
Near Empty	Low	With low sound accompanied by a flashing yellow light
Low Batt. Remind	Medium	With medium sound accompanied by a flashing yellow light
Low Batt. Alarm	High	With high level sound accompanied by a flashing red light
Syringe Disengaged	High	With high level sound accompanied by a flashing red light
Mechanism Error	High	With high level sound accompanied by a flashing red light

OCCLUSION — During a normal infusion, when an occlusion occurs in the syringe tubing system or at the needle, the pump stops immediately. A high level alarm sound is activated with an interval of 5 seconds. The “ALARM” indicator is on with a red flashing light at 2 Hz, 40% cycle. The screen displays “OCCLUSION”. The infusion can only be resumed when the alarm condition is cleared.

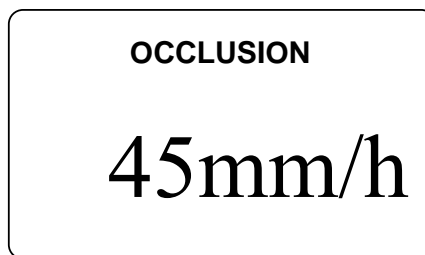

COMPLETED — When the syringe is finished, the pump stops. A high level alarm sound is activated with an interval of 5 seconds. The “ALARM” indicator is on with a red flashing light at 2 Hz, 40% duty cycle. The screen displays “COMPLETED”.

COMPLETED

45mm/h

LOW BATTERY REMIND and ALARM— If the battery runs low, a medium level alarm sound is activated with an interval of 15 seconds. The “LOW BATT” indicator is on with a yellow flashing light at 0.5 Hz, 25% duty cycle. In this situation, the user shall change new batteries immediately. After the Low Batt. reminder the batteries may support the pump for another 30 minutes and then Low Batt. Alarm is activated. 3 minutes after Low Batt. Alarm goes off; the pump will stop the infusion. When the pump is operating under low battery status, a high level alarm sound is activated with an interval of 5 seconds. At the same time the screen displays “LOW BATT” with a red flashing light at 2 Hz, 40% duty cycle.

STOPS IN 3 MINS

45mm/h

LOW BATT STOPS

45mm/h

NEAR EMPTY— When the syringe is almost finished, a low level alarm sound is activated with an interval of 15 seconds, tip 3 times. The “ALARM” indicator is on with a flashing yellow light at 0.5 Hz, 25% duty cycle. The screen displays “NEAR EMPTY”. This is to remind the user of infusion-near-end and the user shall prepare to change a new syringe.

NEAR EMPTY

45mm/h

MECHANISM ERROR — During a normal infusion, if the mechanical system is malfunctioning and the pump cannot continue the operation, the pump will stop immediately. A high level alarm sound is activated with an interval of 5 seconds. The “ALARM” indicator is on with a flashing red light at 2 Hz, 40% duty cycle. The screen displays “MECHANISM ERROR”. Pump should only be used after the alarm status is cleared. Do not use the pump until it is serviced by authorized personnel.

MECHANISM ERROR**45mm/h**

SYRINGE DISENGAGED — If the syringe is disengaged during the infusion, the pump will stop the infusion immediately. A high level alarm sound is activated with an interval of 5 seconds. The “ALARM” indicator is on with a flashing red light at 2 Hz, 25% duty cycle. The screen displays “SYRINGE DISENAG”. Only resume the infusion after the syringe is installed properly.

SYRINGE DISENAG**45mm/h**

SYRINGE NOT INSTALLED — If the user presses the START button with no syringe installed, a medium level alarm sound is activated with an interval of 15 seconds. The “ALARM” indicator is on with a flashing yellow light at 0.5 Hz, 25% duty cycle. The screen displays “SYRINGE DISENAG”. When the syringe is installed properly, the yellow indicator is off, and the alarm sound will be silenced.

SYRINGE DISENAG**45mm/h**

IMPORTANT: This is a portable device, so the sound pressure level is greater than 50dB.



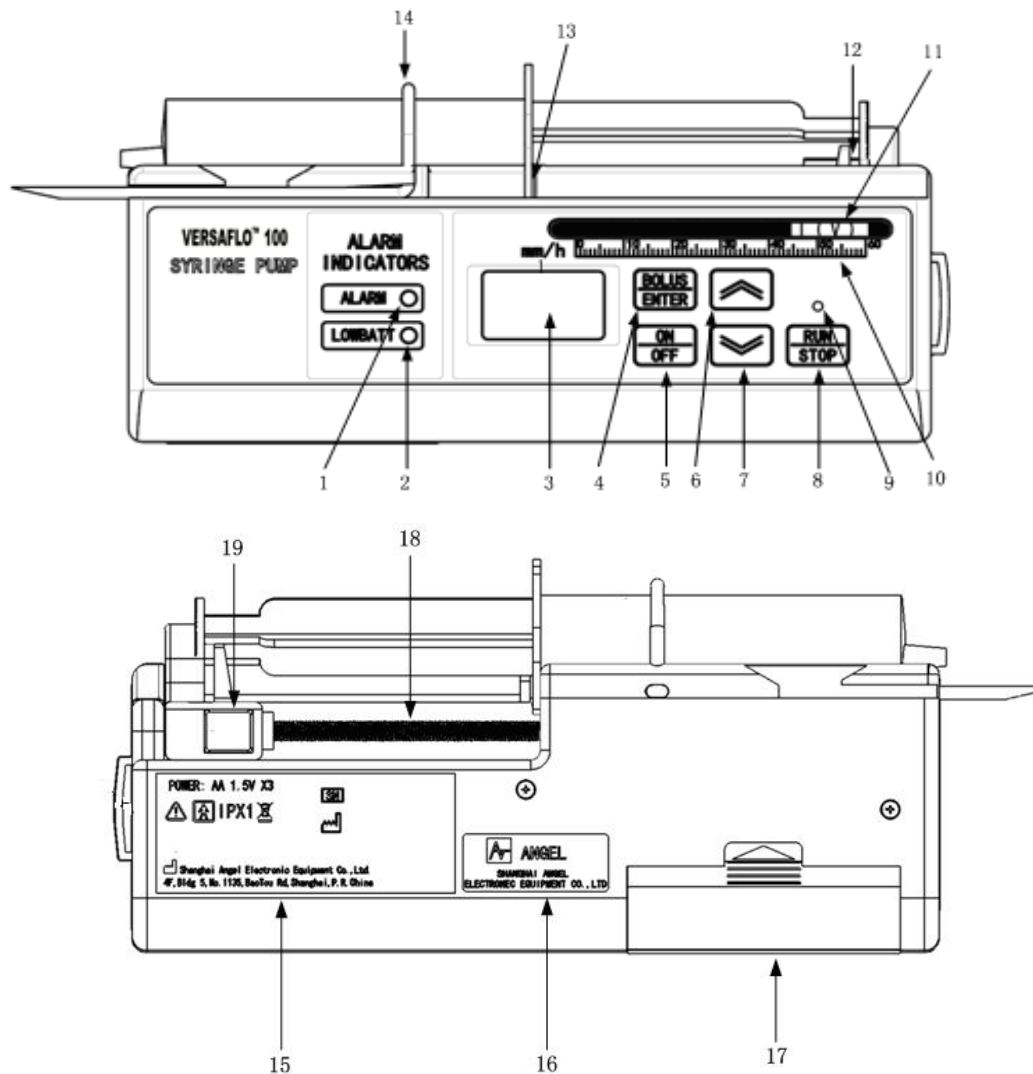

KEYPAD DESCRIPTION

A. Control panel & pump structure



1	Alarm LED indicator	11	Gauge indicator
2	Low Batt. LED indicator	12	Syringe plunger slot
3	OLED displaying screen	13	Syringe flange slot
4	BOLUS/ENTER indicator	14	Syringe securing strap
5	Power switch	15	Product label
6	Increase set-number key	16	Product logo
7	Decrease set-number key	17	Battery compartment
8	RUN/STOP key	18	Lead screw
9	Running LED indicator	19	Pushing mechanism releasing button
10	Rate gauge		

KEYPAD FUNCTIONS

	<p>INCREASE Button –</p> <p>Press to increase the flow rate, hold longer than 0.5 second to accelerate the speed of scrolling.</p>
	<p>DECREASE Button –</p> <p>Press to decrease the flow rate, hold longer than 0.5 second to accelerate the speed of scrolling.</p>
	<p>Power ON/OFF switch. –</p> <p>To turn on or turn off the pump.</p>
	<p>BOLUS/ENTER Button –</p> <p>When the pump is paused, this button is functioned as ENTER key. Press this button to confirm the syringe size and the flow rate settings.</p> <p>When the pump is in the running mode, this button is functioned as BOLUS key. Press and hold it for 2 seconds to activate the bolus. The maximum bolus volume is the syringe volume size.</p> <p>In "near empty" status, bolus function is disabled.</p>
	<p>RUN/STOP Button –</p> <p>When the pump is paused, press this button to start the infusion; the green LED indicator is flashing;</p> <p>While the pump is in the bolus mode, press this button to stop the bolus and to go back to the regular infusion;</p> <p>When the pump is in a normal running status, press this button to stop the infusion; the green LED indicator is off;</p> <p>Press this button to start the bolus after the bolus rate setting is completed.</p>



The maximum bolus volume is no more than 1/4 of the syringe volume size.

PROGRAMMING THE SETTINGS

IMPORTANT: Read this operation manual carefully before operating this product.

1. Select the syringe size

1) Press the power switch ON;

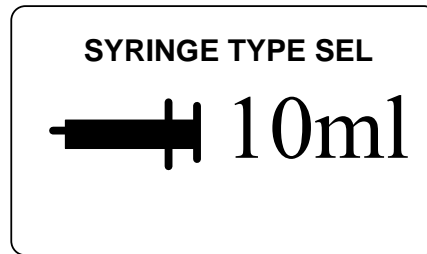

2) the pump goes into the menu of selecting the syringe size. Press  or  to select preferred syringe size. Press ENTER to confirm the setting.
Compatible syringe sizes: 1ml, 3ml, 5ml, 10ml, 20ml syringes.



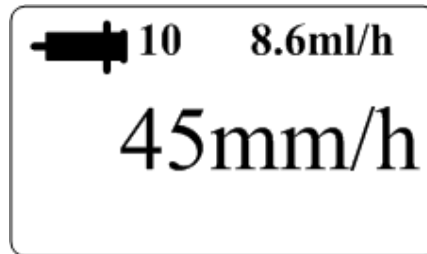

2. Set the flow rate

- 1) After the syringe size is selected, the pump goes into the next menu of setting flow rate.





- 2) Press  or  to select the flow rate. The syringe size, flow rate in mm/h and equivalent flow rate in ml/hr are shown on the screen;



- 3) Press  to confirm the rate setting and to start the infusion. The green LED indicator is flashing to remind of starting the infusion;

- 4) To stop the infusion, press . The green LED indicator is off, which means the infusion has stopped.

3. Set a bolus

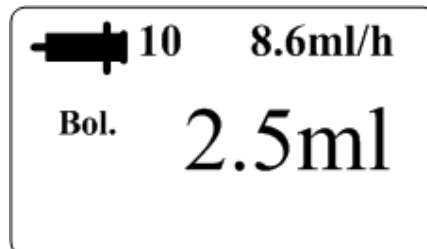
- (1) During a regular infusion, the user may have an additional dose by using  button. Press  and hold for at least 2 seconds, the pump will enter into BOLUS mode;



- (2) Press  or  to select the bolus volume. Bolus volume in ml and corresponding flow rate are shown on the screen. The maximum bolus volume is the syringe volume size;

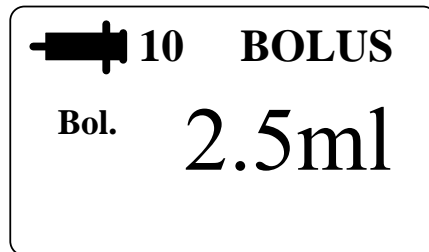

- (3) After the bolus setting is completed, press  to start bolusing. While the bolus is in

progress, the green LED indicator is flashing, the number of bolus volume shown on the screen is decreasing;



(4) When the bolus is completed, a buzzer sets off, reminding the user of bolus completion. The pump automatically switches to the regular infusion mode.

CAUTION: during the time of infusing additional dose (bolus), the regular infusion dose will not stop and is still in progress.

IMPORTANT: during the setting of a bolus, to stop the setting, Press  to set the bolus volume to "0.0" ml, and then press ; the pump will switch to regular infusion mode, and the regular infusion will continue.

To stop a bolus, press ; the pump will stop bolus, and switch to regular infusion mode, and the regular infusion will continue.

 **WARNING:** before starting a bolus, the user must confirm the bolus volume again to ensure a safe infusion.

TROUBLE SHOOTING

Description	Possible Cause	Required Actions
The Pump can not be turned on	<ol style="list-style-type: none"> 1. Circuit overload. 2. Battery is depleted. 3. Battery polarity is wrong. 	<ol style="list-style-type: none"> 1. Change for new batteries. 2. Make sure the battery polarity is correct. 3. Contact authorized personnel for service.
OCCLUSION alarm but no visible in blockage IV line	<ol style="list-style-type: none"> 1. Hidden occlusion can not be seen. 	<ol style="list-style-type: none"> 1. Check carefully the syringe and extension tubing system to clear the occlusion, and then resume the infusion.
Over/under infusing over +/- 5%	<ol style="list-style-type: none"> 1. A new syringe is used without proper calibration settings. 2. The pump has not been sent for calibration for the last 24 months as recommended in this manual. 	<ol style="list-style-type: none"> 1. Stop using the pump. Check the pump accuracy with the currently used syringe brand/size and pump calibration setting according to the manual. 2. Stop using the pump. Contact our authorized distributor for maintenance.
Keypad locked/frozen	<ol style="list-style-type: none"> 1. The pump is running and most keypads are locked. 2. The control buttons are broken. 	<ol style="list-style-type: none"> 1. Stop the pump, and then change the settings with the buttons. 2. Stop using the pump. Contact our authorized distributor for service.

SPECIFICATIONS

1. Environmental Temperatures of Operation:	5°C ~ 40°C		
2. Relative Humidity:	Less than 90%		
3. Atmospheric Pressure:	700hPa-1060hPa		
4. Power Source:	DC 3.6V-4.5V; AA Battery X3		
5. Flow Rate Range:	1-99 mm/hr		
6. Compatible Syringe Sizes:	1ml, 3ml, 5/ml, 10ml, 20ml		
7. Accuracy:	± 2% without syringe		
8. Maximum Infusion Pressure:	No more than 0.12 Mpa with 10ml syringe		
9. Occlusion Alarm Pressure:	0.08 ± 0.04 Mpa with 10ml syringe		
10. Occlusion Alarm Triggering Time and Dose Infused	(With 10ml syringe)		
	Infusion Rate	Occlusion Alarm Pressure	Triggering Time
	Low rate 10 mm/hr	0.08 ± 0.04 Mpa	5'3"
	Medium rate 50 mm/hr	0.08 ± 0.04 Mpa	2'
11. Dimension l x b x h (mm):	166 x 30 x 60		
12. Net Weight:	No More Than 180 g without batteries		

INFUSION ACCURACY OF THE SYSTEM

Accuracy Testing Rate: 10 mm/hr

1. Starting Curve

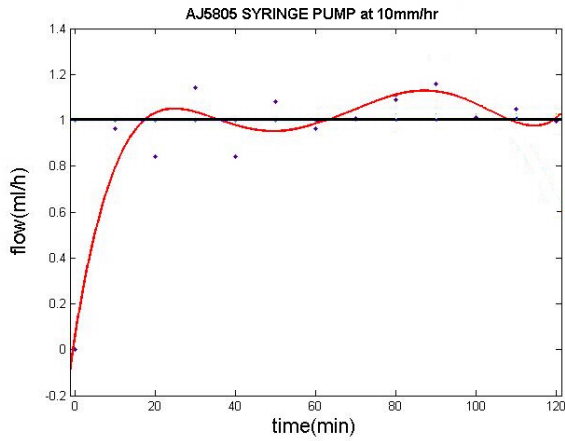

2. Trumpet Curve

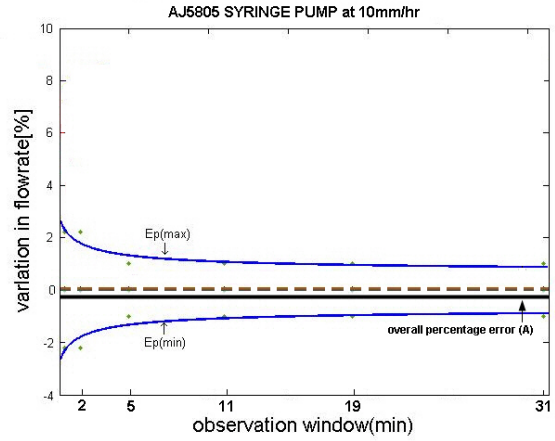

Accuracy Testing Rate: 50 mm/hr

1. Starting Curve

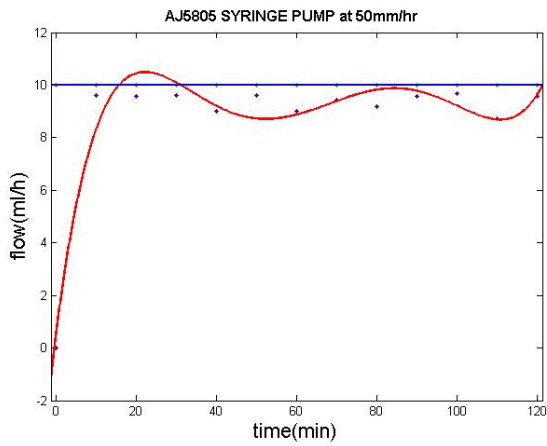

2. Trumpet Curve

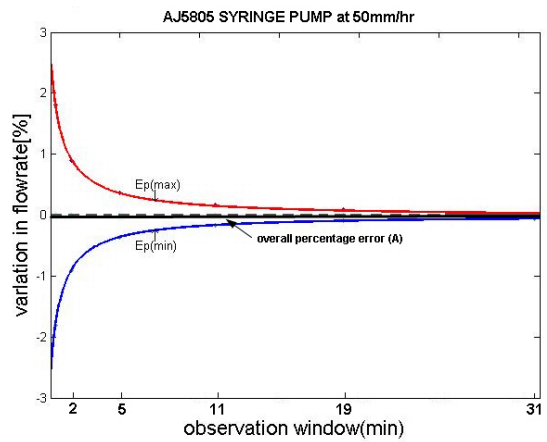

REGULATORY INFORMATION

This syringe pump complies with the following standards:

- 93/42/EEC European directive for medical devices including EN 60601-1-2 and collaterals.
- Electrical Safety (IEC) and Electromagnetic Compatibility standards (EMC)
- Guidance and Manufacturer's Declaration—Electromagnetic Emissions

Electromagnetic Compatibility Precautions

Medical electrical equipment requires special precautions regarding electromagnetic compatibility (EMC). Medical equipment must be installed and put into service according to the EMC information provided in the following documentation.

Guidance and Manufacturer's Declaration Electromagnetic Emissions

Tablet-1

Electromagnetic Immunity for Equipment and Systems Fully Compliant with EN 60601-1-2:2007			
This syringe pump is intended for use in the electromagnetic environment specified below.			
Immunity Test	IEC 60601 Test Level	Compliance Level	Electromagnetic Environment- Guidance
Electrostatic Discharge (ESD) IEC 61000-4-2	± 6kV contact ± 8kV air	± 6kV contact ± 8kV air	Floors should be wood, concrete or ceramic tile. If floors are covered with synthetic material. The relative humidity should be at least 30%.
Power frequency (50/60Hz) magnetic field IEC 61000-4-8	3 A/m	3 A/m	Power frequency magnetic fields should be at levels characteristic of a typical location, in a typical commercial or hospital environment.

ACCESSORIES

Every new pump's package includes:

- a. 1 x User's manual
- b. 4 x AA battery
- c. 1 x QA pass
- d. 1 x Syringe protecting cover
- e. 1 x Syringe securing strap

RECOMMENDED SYRINGE BRANDS

1ml, 3ml, 5ml, 10ml, 20ml syringes: B-D, TERUMO

PACKAGE, TRANSPORTATION AND STORAGE

1. Package: Please save the original package and Styrofoam, put the syringe pump in this original package for storage, and keep the manuals and all accessories.

2. Transportation: Avoid shaking and impact during transportation; keep away from moisture (rain and snow).

3. Storage:

a. If the pump is to be stored for an extended period, it should be cleaned and the batteries taken out. Store in a clean, dry environment.

Environmental temperatures: $-10^{\circ}\text{C} \sim +55^{\circ}\text{C}$

Relative Humidity: Less than 93%

Atmosphere Pressure: 500hPa \sim 1060hPa

Keep away from erosive air or harmful dust. Leaving the batteries inside the pump for a long period of time may discharge the batteries completely and may cause battery leakage; this will damage the pump permanently.

b. Perform operational and safety standard checkout to ensure the pump works properly and infuses accurately before use if the pump is stored more than 3 months.

c. Perform operational and safety standard checkout every 3 months.

MAINTENANCE

Service of this syringe pump must be performed by manufacturer's authorized technicians.

3. SUGGESTED GUIDELINES FOR CLEANING AND STERILIZATION :

- 1) Before cleaning the pump, make sure the power is off.
- 2) Always keep the pump clean, use 70% alcohol on soft cloths to wipe out any fluid on the pump.

- 3) Use EOG (Ethylene oxide gas) to sterilize the pump under the following conditions:

Environmental temperatures: under 58°C

Relative Humidity: Less than 60%

After the sterilization, please keep the room ventilated for 24 hours or longer, or leave the pump in the ventilation device for 8 hours or longer.

IMPORTANT: Avoid using solvents and thinners to clean the pump

⚠WARNING: The operational and safety standard checkout must be performed at least every 24 months by the factory's authorized service representative to ensure the pump works properly and infuses accurately. (not covered by warranty, fees apply)

⚠WARNING: Perform functional tests and ensure that battery is fully charged at least once every month.

The designed life time of this pump is 6-8 years. After designed life time, please have all major components replaced by manufacturer authorized technician or stop use.

4. Pollution-Free Treatment And Recycling

- 1) Remove the batteries before recycling or disposal of the pump.
- 2) The distributors will accept used pumps for proper pollution-free treatment and recycling.

MAINTENANCE SERVICE RECORD

Serial Number: _____

Date of Purchase: _____

Date of Service: _____

Accuracy Calibration

Functional tests

Maintenance Detail:

Serviced by (Print Technician Name): _____

Signature: _____

Service Company Name (Print): _____

Tel: _____

Date of Service: _____

Accuracy Calibration

Functional tests

Maintenance Detail:

Serviced by (Print Technician Name): _____

Signature: _____

Service Company Name (Print): _____

Tel: _____

Date of Service: _____ Accuracy Calibration Functional tests

Maintenance Detail:

Serviced by (Print Technician Name): _____ Signature: _____

Service Company Name (Print): _____ Tel: _____

LIMITED WARRANTY

The syringe pump has been carefully manufactured from the highest quality components. The pump is guaranteed against defects in material and workmanship for two (2) years from date of purchase by the original purchaser. User should keep the service record according to manufacturer's instruction to keep the warranty valid.

Manufacturer's obligation, or that of its designated representative under this Limited Warranty, shall be limited, at our option, to repairing or replacing the pump, which upon examination, is found to be defective in material or workmanship. The repair or replacement of any product under this Limited Warranty shall not extend the above mentioned Warranty period.

All repairs under this Limited Warranty should be undertaken only by qualified, trained service personnel. In the event that a pump is found to be defective during the warranty period, the purchaser shall notify manufacturer or its designated representative within thirty (30) days after such defect is discovered. The defective pump should be sent immediately to manufacturer or its designated representative for inspection, repair or replacement.

Material returned should be properly packaged to avoid shipping damage.

This Limited Warranty shall not apply to defects or damage caused, wholly or in part, by negligence, spill fluids, dropping of the pump, misuse, abuse, improper installation or alteration by anyone other than qualified, trained personnel; or to damage resulting from inadequate packaging in returning the pump.

This Limited Warranty is the sole and entire warranty pertaining to manufacturer's products and is in lieu of and excludes all other warranties of any nature whatsoever, whether stated, or implied or arising by operation of law, trade, usage or course of dealing, including but not limited to, warranties of merchantability and warranties of fitness for a particular purpose. Purchaser expressly agrees that the remedies granted to it under this limited warranty are purchaser's sole and exclusive remedies with respect to any claim of purchaser arising under this Limited Warranty.

EXCLUSIONS (WHAT IS NOT COVERED)

1. Accessories used with this pump such as pole clamp, power cord etc. are not covered under this limited warranty policy.
2. This warranty becomes void if opened or serviced by un-authorized personnel.
3. This warranty does NOT cover freight cost, insurance and any other incidental charges.
4. Failure to service the pump periodically as scheduled will void this warranty policy.
5. This warranty becomes void if the pump shows evidence of having been dropped, impact, sand and/or water damage, mishandling, tampering, battery or chemical corrosion, use contrary to this instruction manual.