

M250 Accessory Kit

Order 
 Medical and
 Animal Health
 Parts Online

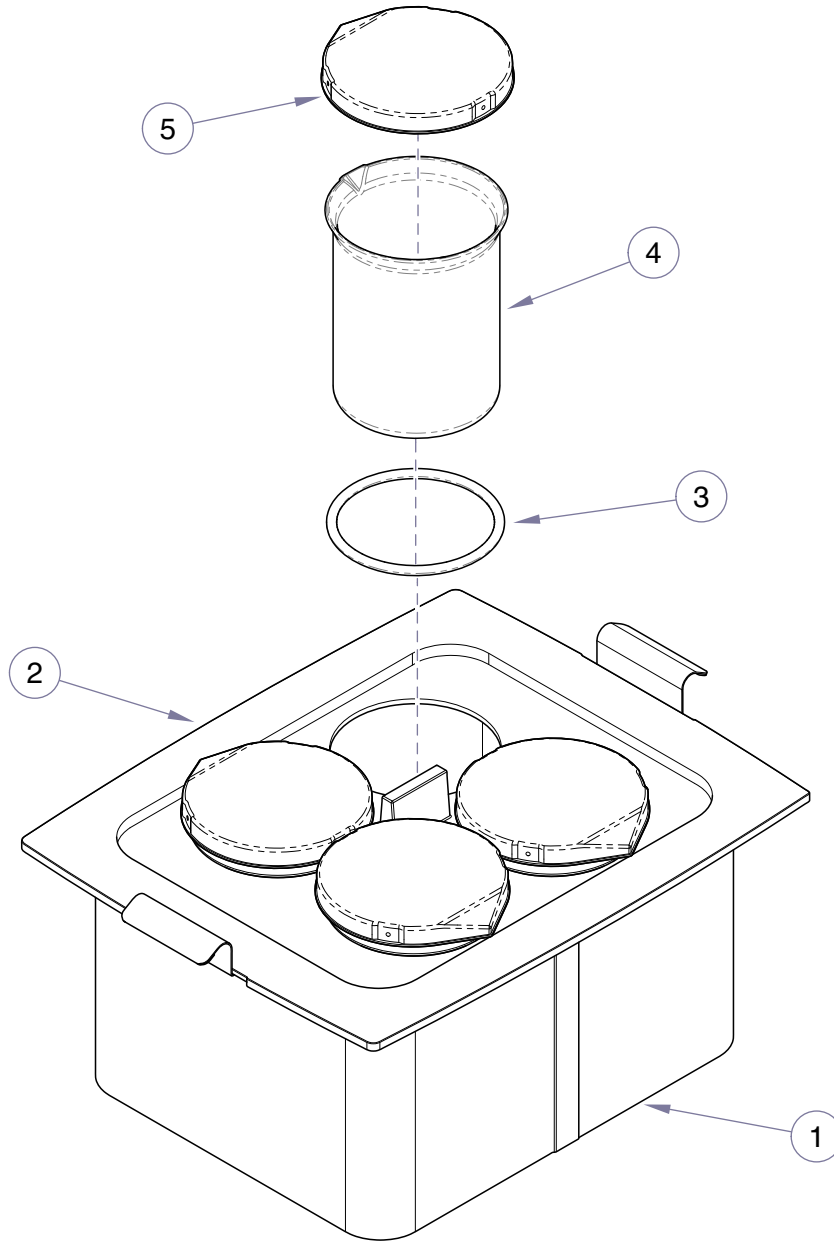

SA118500i

Item	Part No.	Description	Qty.	Item	Part No.	Description	Qty.
	9A287001	M250 Accessory Kit (Includes Items 1 thru 5 plus packaging)	1	3	• 053-1782-00	• Beaker Rubber O-Ring	4
1	• 030-1647-00	• M250 Safety Basket	1	4	• 053-1779-00	• Glass Beaker (600ml)	4
2	• 053-1781-00	• M250 Plastic Beaker Cover	1	5	• 053-1778-00	• Plastic Beaker Cover	4

Always Specify Model & Serial Number