

# M150 Safety Basket

Order   
 Medical and  
 Animal Health  
 Parts Online

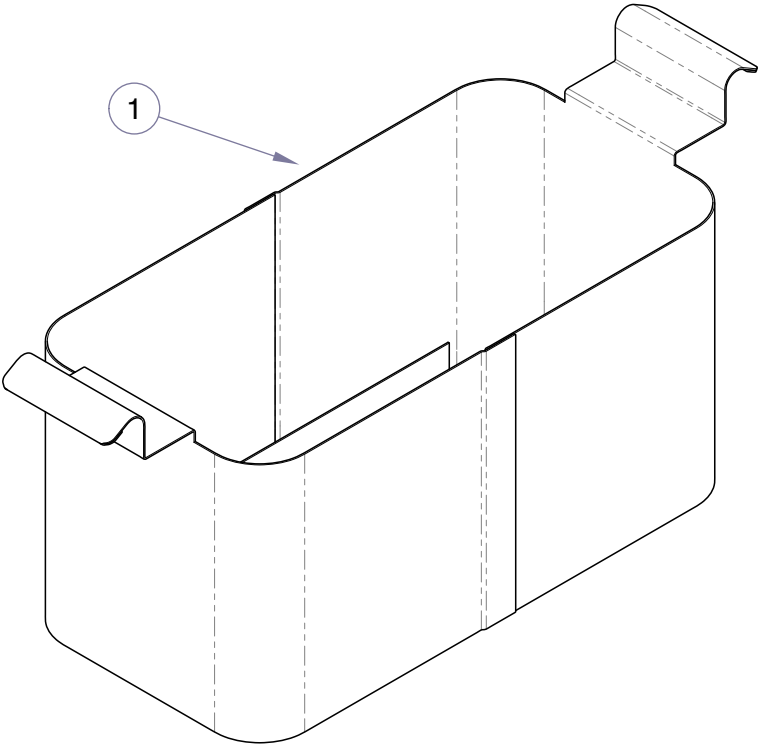

SA118800i

Item	Part No.	Description	Qty.	Item	Part No.	Description	Qty.
	9A290001	M150 Safety Basket (Includes Items 1 plus packaging) .....	1	1	•030-1646-00	•M150 Safety Basket .....	1

**Always Specify Model & Serial Number**