

M550 Cassette Basket

Order 
 Medical and
 Animal Health
 Parts Online

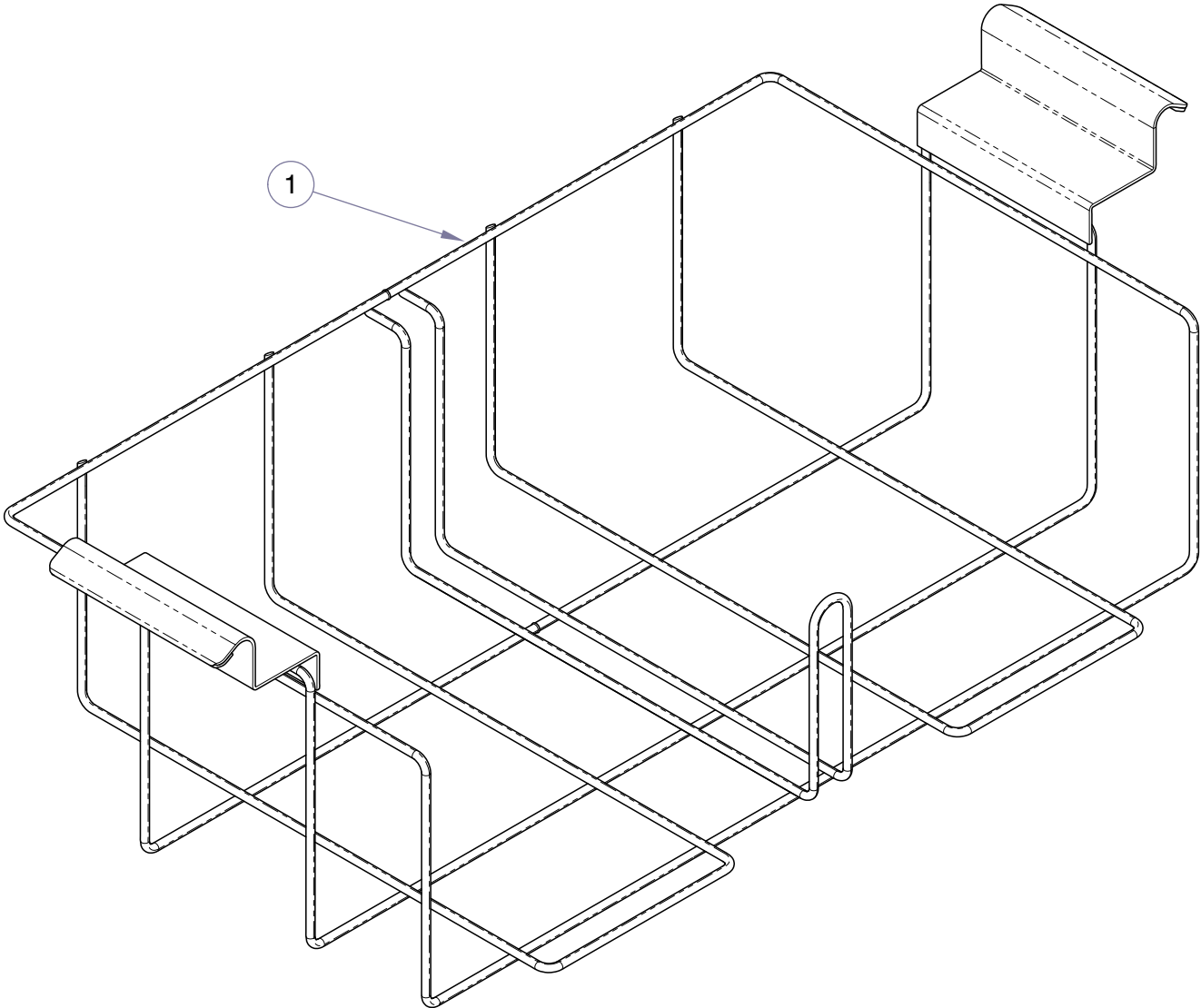

SA1793i

Item	Part No.	Description	Qty.	Item	Part No.	Description	Qty.
	9A407001	M550 Cassette Rack Accessory (Includes Items 1 plus packaging)	1	1	• 030-1657-00	• M550 Cassette Rack	1

Always Specify Model & Serial Number